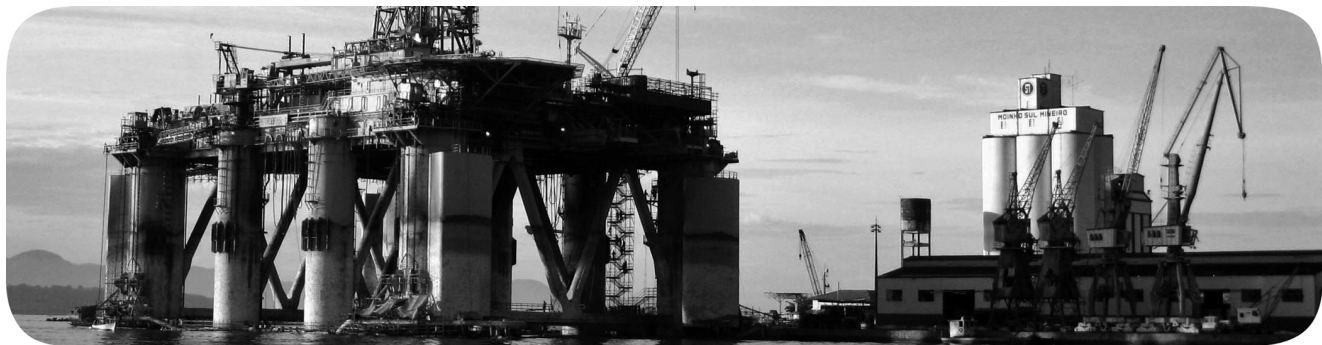


## Guard I/O EtherNet/IP Safety Modules

Catalog Numbers 1732ES-IB16, 1732ES-IB8XOB8, 1732ES-IB8XOBV4, 1732ES-IB12XOB4, 1732ES-IB12XOBV2, 1791ES-IB16, 1791ES-IB8XOBV4



## Important User Information

Read this document and the documents listed in the additional resources section about installation, configuration, and operation of this equipment before you install, configure, operate, or maintain this product. Users are required to familiarize themselves with installation and wiring instructions in addition to requirements of all applicable codes, laws, and standards.

Activities including installation, adjustments, putting into service, use, assembly, disassembly, and maintenance are required to be carried out by suitably trained personnel in accordance with applicable code of practice.

If this equipment is used in a manner not specified by the manufacturer, the protection provided by the equipment may be impaired.

In no event will Rockwell Automation, Inc. be responsible or liable for indirect or consequential damages resulting from the use or application of this equipment.

The examples and diagrams in this manual are included solely for illustrative purposes. Because of the many variables and requirements associated with any particular installation, Rockwell Automation, Inc. cannot assume responsibility or liability for actual use based on the examples and diagrams.

No patent liability is assumed by Rockwell Automation, Inc. with respect to use of information, circuits, equipment, or software described in this manual.

Reproduction of the contents of this manual, in whole or in part, without written permission of Rockwell Automation, Inc., is prohibited

Throughout this manual, when necessary, we use notes to make you aware of safety considerations.



**WARNING:** Identifies information about practices or circumstances that can cause an explosion in a hazardous environment, which may lead to personal injury or death, property damage, or economic loss.



**ATTENTION:** Identifies information about practices or circumstances that can lead to personal injury or death, property damage, or economic loss. Attentions help you identify a hazard, avoid a hazard, and recognize the consequence.

---

### **IMPORTANT**

Identifies information that is critical for successful application and understanding of the product.

---

Labels may also be on or inside the equipment to provide specific precautions.



**SHOCK HAZARD:** Labels may be on or inside the equipment, for example, a drive or motor, to alert people that dangerous voltage may be present.



**BURN HAZARD:** Labels may be on or inside the equipment, for example, a drive or motor, to alert people that surfaces may reach dangerous temperatures.



**ARC FLASH HAZARD:** Labels may be on or inside the equipment, for example, a motor control center, to alert people to potential Arc Flash. Arc Flash will cause severe injury or death. Wear proper Personal Protective Equipment (PPE). Follow ALL Regulatory requirements for safe work practices and for Personal Protective Equipment (PPE).

---

	<b>Summary of Changes</b> .....	7
	<b>Preface</b> .....	9
	About the Specifications and Dimensions in This Manual .....	9
	Terminology .....	9
	Additional Resources .....	10
	<b>Chapter 1</b>	
<b>Safety Function Operation</b>	Safe State .....	11
	Self-diagnostic Functions .....	12
	Configuration Lock .....	12
	I/O Status Data .....	12
	Safety Inputs .....	13
	Using a Test Output with a Safety Input. ....	13
	Set Dual-channel Mode and Discrepancy Time .....	17
	Dual-channels, Equivalent .....	17
	Dual-channels, Complementary .....	19
	Safety Input Fault Recovery .....	20
	Input Delays .....	20
	Muting Lamp Operation .....	21
	Safety Outputs .....	23
	Safety Output with Test Pulse .....	23
	Dual-channel .....	24
	Single-channel .....	25
	Safety Output Fault Recovery .....	25
	Controlling Devices .....	26
	<b>Chapter 2</b>	
<b>About the Modules</b>	Before You Begin .....	27
	Firmware Information and Downloads .....	28
	Functional Safety Certificates .....	28
	Understand Suitability for Use .....	28
	1791ES-IB16 and	
	1791ES-IB8XOBV4 Modules North American Hazardous Location	
	Approval .....	29
	Follow Precautions for Use .....	30
	I/O Module Overview .....	31
	Selecting a Power Supply .....	33
	Programming Requirements .....	34
	CIP Safety in	
	EtherNet/IP Safety Architectures .....	34
	Device Level Ring (DLR) .....	35
	Identify Major Parts of the Module .....	37

	<b>Chapter 3</b>	
<b>Install the Module</b>	Environment and Enclosure.....	39
	For 1791ES Modules .....	39
	For 1732ES Modules .....	40
	Prevent Electrostatic Discharge.....	41
	Environmental Considerations for Use.....	42
	Follow Wiring Precautions.....	42
	Follow DC Power Supply Precautions .....	45
	Mount the Module.....	45
	Module Spacing .....	46
	Mount the 1791ES Modules on a DIN Rail.....	48
	Mount the 1732ES Modules on a Wall or Panel.....	49
	Grounding the 1732ES Modules.....	51
	Make Connections for 1791ES Modules .....	52
	Power Connections.....	52
	EtherNet/IP Connections.....	53
	I/O Connections.....	53
	Make Connections for 1732ES Modules .....	55
	Power Connections.....	55
	Power Pass Through.....	55
	EtherNet/IP Connections.....	59
	I/O Connections.....	60
	Label the IP Address and Device Connections .....	62
	<b>Chapter 4</b>	
<b>Wiring Examples</b>	Wiring Examples for Safety Categories.....	64
	Wiring by Application.....	67
	<b>Chapter 5</b>	
<b>Configure the I/O Modules</b>	Set the IP Address.....	75
	Add Modules to the I/O Configuration Tree .....	77
	Configure the Module Properties.....	79
	Set the IP Address in the Programming Software .....	80
	Change the Module Definition .....	80
	Configure the Safety Connections .....	86
	Configuration Ownership – Reset Ownership .....	87
	Configuration Signature .....	88
	Configure the Module Inputs .....	88
	Configure the Test Outputs.....	90
	Configure the Module Outputs .....	91
	Save and Download the Module Configuration.....	92
	<b>Chapter 6</b>	
<b>Replace Guard I/O Modules</b>	Manually Set the Safety Network Number .....	93
	Reset the Module to Out-of-box Configuration.....	94
	Replace a Module in a GuardLogix System .....	94

	Configure Only When No Safety Signature Exists.....	95
	Configure Always .....	95
	<b>Chapter 7</b>	
<b>Interpret the Module Status Indicators</b>	Module Status Indicator Depictions .....	97
	Module Status Indicator Descriptions.....	98
	<b>Appendix A</b>	
<b>Get Diagnostic Status from Modules by Using Explicit Messaging</b>	Get Status Messages from 1791ES-IB8XOBV4 Modules .....	102
	Get Status Messages from 1791ES-IB16 Modules .....	107
	Get Status Messages from 1732ES Modules .....	112
	1732ES-IB12XOB4 Modules.....	112
	1732ES-IB12XOBV2 Modules.....	117
	1732ES-IB16 Modules.....	122
	1732ES-IBXOB8 Modules.....	127
	1732ES-IB8XOBV4 Modules .....	132
	I/O Data Supported by Each Module.....	136
	I/O Assembly and Reference Data .....	140
	1791ES Modules .....	140
	1732ES Modules .....	143
	Explicit Messages.....	149
	<b>Appendix B</b>	
<b>Safety Data</b>	Calculated Values .....	151
	<b>Appendix C</b>	
<b>Configuration Reference Information</b>	Parameter Groups.....	159
	<b>Appendix D</b>	
<b>Specifications</b>	Technical Specifications .....	161
	1791ES Modules .....	161
	1732ES Modules .....	163
	Environmental Specifications .....	166
	Certifications .....	168
	Europe .....	168
	North America.....	169
	Japan .....	169
	EC Directives.....	169
	EMC Directive.....	169
	Compliance with EC Directives .....	169
	<b>Index</b> .....	171

**Notes:**

## Summary of Changes

This manual contains new and updated information as indicated in this table.

Topic	Page
Updated graphics for current programming software version.	Throughout
Added the following catalog numbers: 1732ES-IB16, 1732ES-IB8XOB8, and 1756-IBXOBV4.	Throughout
Deleted Studio 5000® information from Preface.	9
Added publications to the Additional Resources section.	10
Updated Attention statement.	30
Added the following catalog numbers to Table 1: 1732ES-IB16, 1732ES-IB8XOB8, and 1756-IBXOBV4.	33
Deleted the About the Catalog Numbers section.	33
Updated the Programming Requirements section with catalog numbers and RSLogix 5000® versions.	34
Added Device Level Ring (DLR) section.	35
Changed section title to Safety Function Operation.	11
Added Attention statements to Safety Inputs section.	13
Added the following catalog numbers to Table 2: 1732ES-IB16, 1732ES-IB8XOB8, and 1756-IBXOBV4.	14
Added the following catalog numbers to Table 5: 1732ES-IB16, 1732ES-IB8XOB8, and 1756-IBXOBV4.	23
Added Attention statement.	49
Added 1732ES Module Physical Dimensions illustrations.	50
Corrected information in Table 19.	60
Added text at the beginning of Chapter 3, Wiring Examples.	63
Moved Set the IP Address section, with approved text, to Chapter 4, Configure the I/O Modules.	75
Updated steps in the Add Modules to the I/O Configuration Tree to reflect the current programming software procedure.	77
Added a reference to ENET-WP032 to the Set the IP Address in the Logix Designer Application section.	80
Added Chapter 5, Replacing Guard I/O™ Modules.	93
Combined tables in Chapter 6, Interpret the Module Status Indicators for 1791ES modules and 1732ES modules.	97
Added figure titles to Appendix A, Get Diagnostic Status from Modules by Using Explicit Messaging.	101
Added specific 1732ES module sections to account for available modules.	112
Added the following catalog numbers to Table 23: 1732ES-IB16, 1732ES-IB8XOB8, and 1756-IBXOBV4.	136
Added the following tables to the I/O Data Supported by Each Module section: Table 28, Table 29, and Table 30.	138, 139
Added the following tables to the I/O Assembly and Reference Data section: Table 37, Table 38, Table 40, and Table 41.	144, 145, 148
Updated Table 39 and Table 42 in the I/O Assembly and Reference Data .	146, 148
Corrected information in Table 55.	148
Updated technical and environmental Specifications.	161
Updated Certifications.	168
Updated GuardLogix® manual reference information in the Calculated Values section.	151
Updated all figures and tables in Appendix B.	151
Updated the Technical Specifications for the 1732ES modules.	161

**Notes:**



## About the Specifications and Dimensions in This Manual

Product specifications and accessories can change at any time based on improvements and other reasons. Consult with your Rockwell Automation representative to confirm actual specifications of purchased product. Dimensions and weights are nominal and are not for use for manufacturing purposes, even when tolerances are shown.

## Terminology

See this table for the meaning of common terms.

Term	Definition
1732ES modules	Also known as ArmorBlock® Guard I/O™ EtherNet/IP Safety Modules.
1791ES modules	Also known as CompactBlock™ Guard I/O EtherNet/IP Safety Modules.
Connection	Logical communication channel for communication between nodes. Connections are maintained and controlled between masters and slaves.
DLR	Acronym for Device Level Ring, a type of network topology.
EDS	Acronym for Electronic Data Sheet, a template that RSNetWorx™ software uses to display the configuration parameters, I/O data profile, and connection-type support for a given I/O module. These are simple text files used by RSNetWorx software for you to identify products and commission them on a network.
L-	Output +24V DC common.
M	Sinking output common channel, output switches to the common voltage.
MTBF	Acronym for mean time between failure, the average time between failure occurrences.
NAT	Acronym for network address translation, a service that lets modules reuse IP addresses throughout a network.
ODVA	Acronym for Open DeviceNet Vendor Association, a nonprofit association of vendors established for the promotion of CIP networks.
P	Sourcing output channel, output switches to the plus voltage.
PFD	Acronym for probability of failure on demand, the average probability of a system to fail to perform its design function on demand.
PFH	Acronym for probability of failure per hour, the probability of a system to have a dangerous failure occur per hour.
Proof test	Periodic test performed to detect failures in a safety-related system so that, if necessary, the system can be restored to an as-new condition or as close as practical to this condition.
S+	Output +24V DC.
SNN	Acronym for safety network number, which uniquely identifies a network across all networks in the safety system. You are responsible for assigning a unique number for each safety network or safety sub-net within a system.
Standard	Devices or portions of devices that do not participate in the safety function.

## Additional Resources

These documents contain additional information concerning related products from Rockwell Automation.

Resource	Description
Allen-Bradley® Stratix® 5700 Network Address Translation (NAT) White Paper, publication <a href="#">ENET-WP032</a>	Provides information about NAT.
ArmorBlock Guard I/O EtherNet/IP Safety Modules Product Information, publication <a href="#">1732ES-PC001</a>	Provides instructions to install ArmorBlock Guard I/O EtherNet/IP Safety modules.
CompactBlock Guard I/O EtherNet/IP Safety Modules Installation Instructions, publication <a href="#">1791ES-IN001</a>	Provides specifications and information related to the 1791ES Guard I/O modules.
Compact GuardLogix® 5370 Controllers User Manual, publication <a href="#">1769-UM022</a>	Provides information on how to install, configure, program, and use Compact GuardLogix 5370 controllers.
EtherNet/IP Embedded Switch Technology Application Guide, publication <a href="#">ENET-AP005</a>	Describes how to install, configure, and maintain linear and Device Level Ring (DLR) networks using Rockwell Automation® EtherNet/IP devices with embedded switch technology.
Ethernet Design Considerations Reference Manual, publication <a href="#">ENET-RM002</a>	Describes the required media components and how to plan for and install these required components.
GuardLogix 5570 and Compact GuardLogix 5370 Controller Systems Safety Reference Manual, publication <a href="#">1756-RM099</a>	Provides information on safety application requirements for GuardLogix 5570 controllers in Studio 5000 Logix Designer® projects.
GuardLogix 5570 Controllers User Manual, publication <a href="#">1756-UM022</a>	Provides information on how to install, configure, program, and use GuardLogix 5570 controllers in Studio 5000 Logix Designer projects.
GuardLogix Controller Systems Safety Reference Manual, publication <a href="#">1756-RM093</a>	Provides information on safety application requirements for GuardLogix 5560 and 5570 controllers in Studio 5000 Logix Designer projects.
GuardLogix Controllers User Manual, publication <a href="#">1756-UM020</a>	Provides information on how to install, configure, program, and use GuardLogix 5560 and 5570 controllers in Studio 5000 Logix Designer projects.
GuardLogix Safety Application Instructions Safety Reference Manual, publication <a href="#">1756-RM095</a>	Provides reference information describing the GuardLogix Safety Application Instruction Set.
ODVA Media Planning and Installation Manual, publication <a href="#">00148-BR00</a> , available from the EtherNet/IP™ Library at <a href="#">ODVA.org</a>	Describes the required media components and how to plan for and install these required components.
Switched Mode Power Supply Specifications Technical Data, publication <a href="#">1606-TD002</a>	Provides specifications and more information for the switched mode power supplies.
Industrial Automation Wiring and Grounding Guidelines, publication <a href="#">1770-4.1</a>	Provides general guidelines for installing a Rockwell Automation industrial system.
Product Certifications website, <a href="http://www.rockwellautomation.com/global/certification/overview.page">http://www.rockwellautomation.com/global/certification/overview.page</a>	Provides declarations of conformity, certificates, and other certification details.

You can view or download publications at <http://www.rockwellautomation.com/global/literature-library/overview.page>. To order paper copies of technical documentation, contact your local Allen-Bradley distributor or Rockwell Automation sales representative.

## Safety Function Operation

Topic	Page
Safe State	11
Self-diagnostic Functions	12
Configuration Lock	12
I/O Status Data	12
Safety Inputs	13
Muting Lamp Operation	21
Safety Outputs	23
Controlling Devices	26

Read this chapter for information related to the safety functions of the modules. Also included is a brief overview on international standards and directives that you must be familiar with.

### Safe State



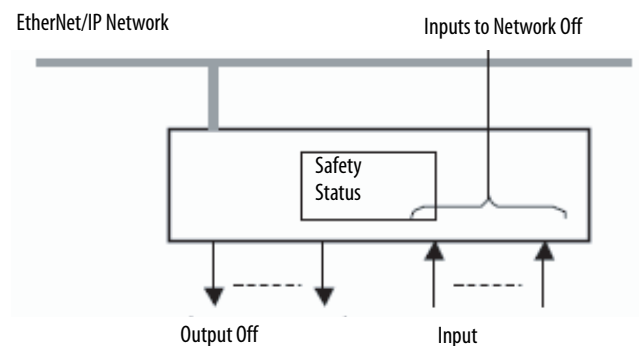
#### **ATTENTION:** Safety State of the Module

- Safety state of the inputs and outputs is defined as the off state.
- Safety state of the module and its data is defined as the off state.
- Use the Guard I/O™ module only in applications where the off state is the safety state.

The following status is the safety state of the Guard I/O modules:

- Safety outputs: off
- Safety input data to network: off

**Figure 1 - Safety Status**



The module is designed for use in applications where the safety state is the off state.

## Self-diagnostic Functions

Self-diagnostics are performed when the power is turned on and periodically during operation. If a fatal internal module error occurs, the red module status (MS) indicator illuminates, and the safety outputs and input data and status to the network turn off.

## Configuration Lock

After configuration data has been downloaded and verified, the configuration data within the module can be protected.

For GuardLogix® systems, the status indicator is not used. For information about safety signatures, see the appropriate GuardLogix Safety Reference Manual, which is listed in the [Additional Resources on page 10](#).

## I/O Status Data

The module provides status data for monitoring the I/O circuits and I/O data. The status data includes the following data, which the controllers can read. 1 = ON/Normal, and 0 = OFF/Fault/Alarm.

- Individual point input status
- Combined input status
- Individual point output status
- Combined output status
- Individual test output status
- Individual output readback (actual ON/OFF state of the outputs)

Status data indicate whether each safety input, safety output, or test output is normal (normal status: ON, faulted status: OFF). For fatal errors, communication connections can be broken, so the status data cannot be read.

Combined status is provided by an AND of the status of all safety inputs or all safety outputs. When all inputs or outputs are normal, the respective combined status is ON. When one or more of them has an error, the respective combined status is OFF. This status is known as the combined safety input status or combined safety output status.

## Safety Inputs

Read this section for information about safety inputs and their associated test outputs. A safety input can be used with test outputs. Safety inputs are used to monitor safety input devices.

### Using a Test Output with a Safety Input

A test output can be used in combination with a safety input for short circuit detection. Configure the test output as a pulse test source and associate it to a specific safety input.



**ATTENTION:** You can configure Test Outputs to be used as standard outputs. You can connect actuators to Test Output points that are expecting a Standard configuration. Test Output points configured as Pulse Test or Power Supply become active whenever you apply input power to the module. These configured functions are independent of the I/O connections to the module.

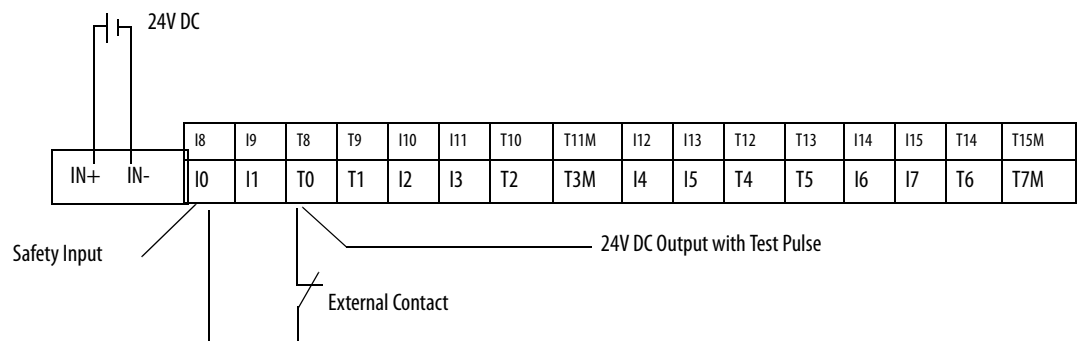


**ATTENTION:** If a module with Test Outputs configured as Pulse Test or Power Supply is incorrectly installed in an application where actuators are connected to these Test Output points, the actuators are activated when input power is applied. To prevent this possibility, follow these procedures.

- When installing or replacing a module, be sure that the module is correctly configured for the application or in the out-of-box condition before applying input power.
- Reset modules to their out-of-box condition when removing them from an application.
- Be sure that all modules in replacement stock are in their out-of-box condition.

The test output can also be used as a power supply to source 24V DC for an external input circuit.

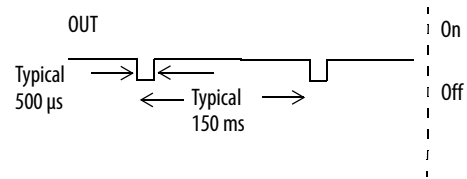
**Figure 2 - Example Use of a 1791ES-IB16 Module**



**Table 1 - Typical Pulse Width and Period**

Pulse Width	Period
500 $\mu$ s	150 ms

**Figure 3 - Test Pulse in a Cycle**

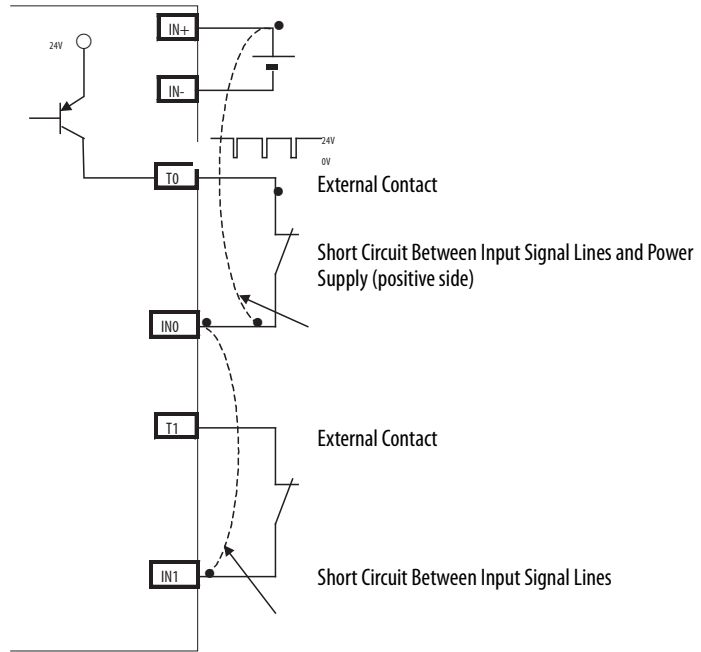


**ATTENTION:** Do not use test outputs as safety outputs. Test outputs do not function as safety outputs.

---

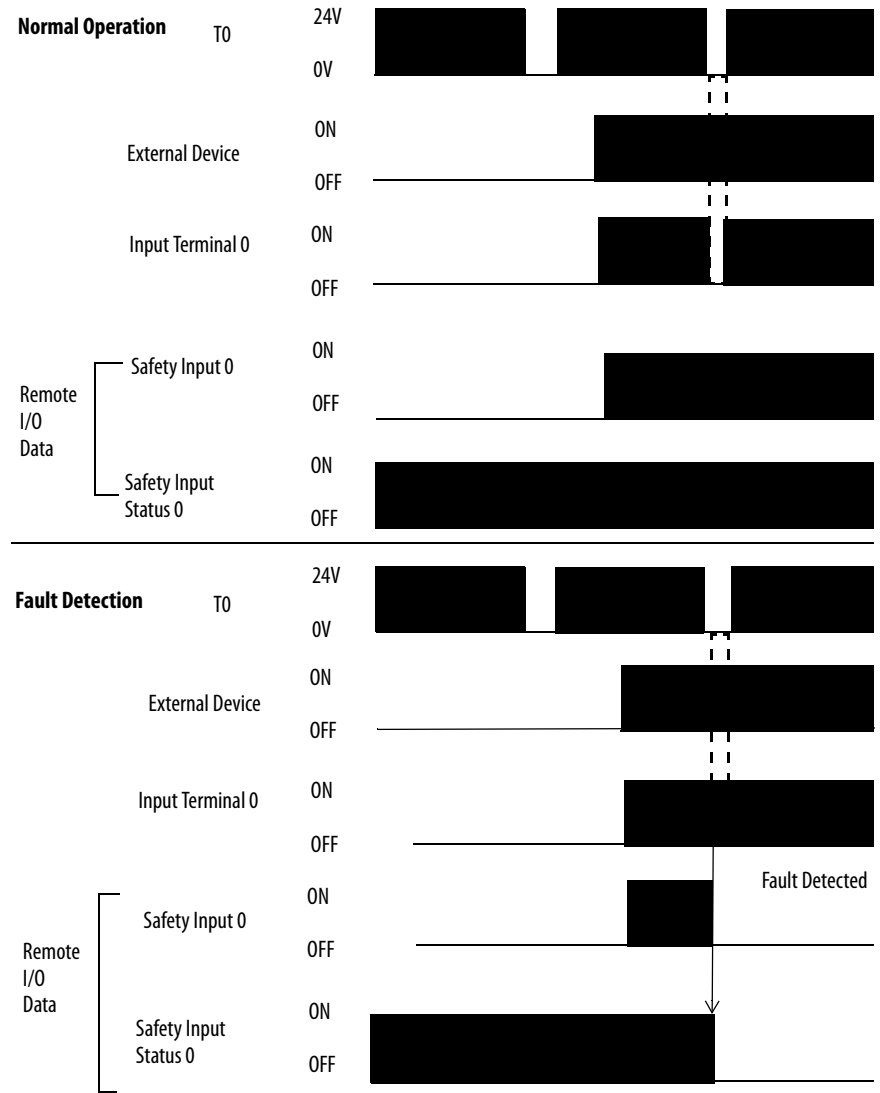
When the external input contact is closed, a test pulse is output from the test output terminal to diagnose the field wiring and input circuitry. By using this function, short circuits between input signal lines and the power supply (positive side), and short circuits between input signal lines can be detected.

**Figure 4 - Short Circuit Between Input Signal Lines**



If an error is detected, safety input data and safety input status turns off.

**Figure 5 - Single Channel Normal Operation and Fault Detection (not to scale)**





## Set Dual-channel Mode and Discrepancy Time

To support redundant channel safety devices, the consistency between signals on two channels can be evaluated. Either equivalent or complementary can be selected. This function monitors the time during which there is a discrepancy between the two channels.

If the length of the discrepancy exceeds the configured discrepancy time, the safety input data and the individual-safety input status turn off for both channels. The configured discrepancy time is 0...65,530 ms in increments of 10 ms.

---

**IMPORTANT** The dual-channel function is used with two consecutive inputs that are paired together, this process starts at an even input number, such as inputs 0 and 1; 2 and 3; and so on.

---



---

**IMPORTANT** Do not set the discrepancy time longer than necessary. The purpose of the discrepancy time is to allow for normal differences between contact switching when demands are placed on safety inputs. For this testing to operate correctly, only one demand on the safety input is expected during the discrepancy time. If the discrepancy time is set too high, and multiple demands occur during this time, then both safety input channels will fault.

---

[Table 2](#) shows the relation between input terminal states and controller input data and status.

**Table 2 - Terminal Input Status and Controller I/O Data**

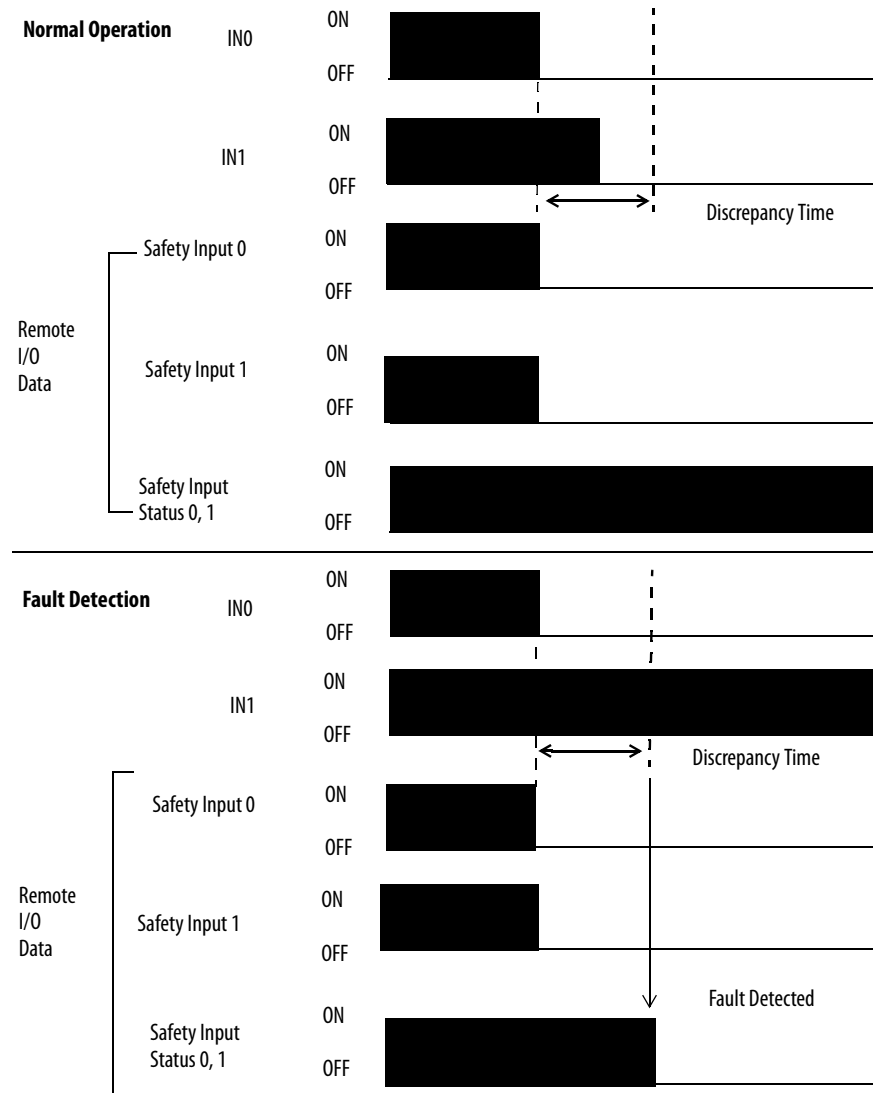
Dual-channel Mode	Input Terminal		Controller Input Data and Status				Dual-channel Resultant Data	Dual-channel Resultant Status
	IN0	IN1	Safety Input 0 Data	Safety Input 1 Data	Safety Input 0 Status	Safety Input 1 Status		
Dual-channels, Equivalent	OFF	OFF	OFF	OFF	ON	ON	OFF	Normal
	OFF	ON	OFF	OFF	OFF	OFF	OFF	Fault
	ON	OFF	OFF	OFF	OFF	OFF	OFF	Fault
	ON	ON	ON	ON	ON	ON	ON	Normal
Dual-channels, Complementary	OFF	OFF	OFF	ON	OFF	OFF	OFF	Fault
	OFF	ON	OFF	ON	ON	ON	OFF	Normal
	ON	OFF	ON	OFF	ON	ON	ON	Normal
	ON	ON	OFF	ON	OFF	OFF	OFF	Fault

### Dual-channels, Equivalent

In Equivalent mode, both inputs of a pair must typically be in the same (equivalent) state. When a transition occurs in one channel of the pair, before the transition of the second channel of the pair, a discrepancy occurs. If the second channel transitions to the appropriate state before the discrepancy time elapses, the inputs are considered equivalent. If the second transition does not

occur before the discrepancy time elapses, the channels fault. In the fault state, the input and status for both channels are set low (off). When configured as an equivalent dual pair, the data bits for both channels are sent to the controller as equivalent, both high or both low.

**Figure 6 - Equivalent, Normal Operation, and Fault Detection (not to scale)**

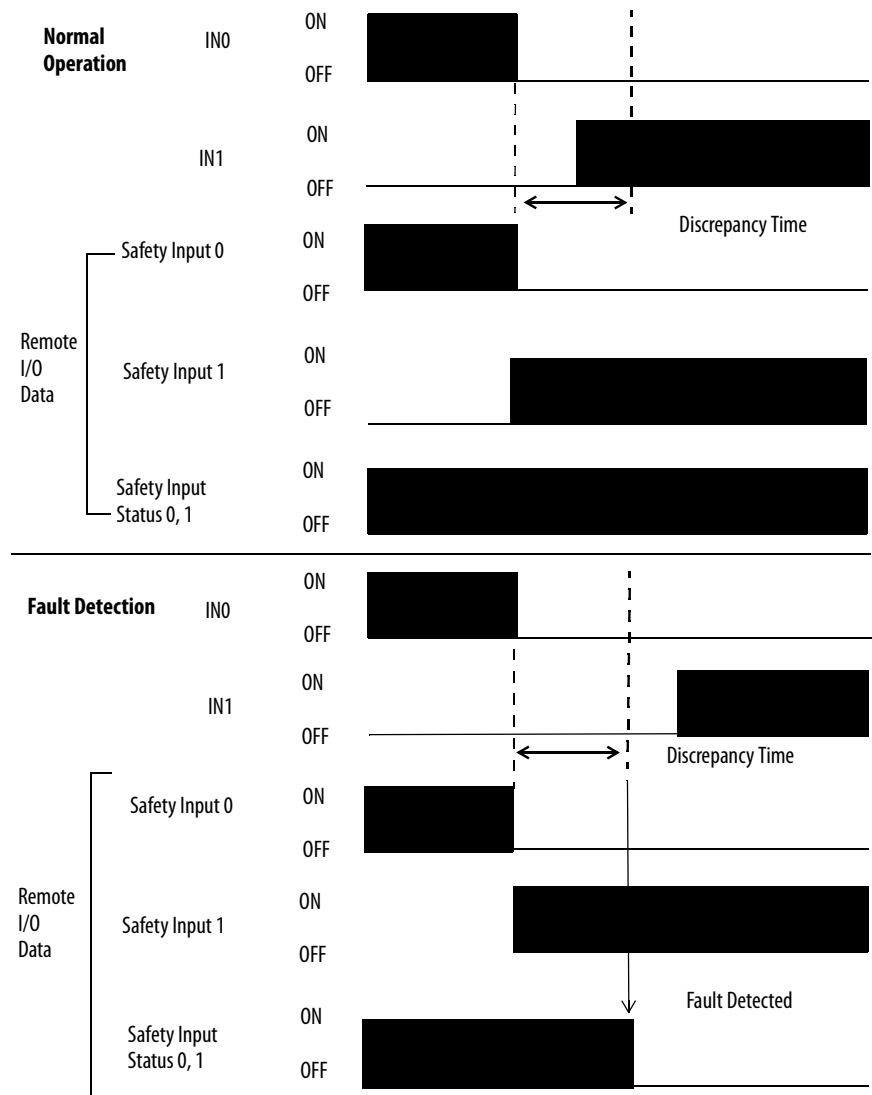


## Dual-channels, Complementary

In Complementary mode, the inputs of a pair are typically in the opposite (complementary) state. When a transition occurs in one channel of the pair before the transition of the second channel of the pair, a discrepancy occurs. If the second channel transitions to the appropriate state before the discrepancy time elapses, the inputs are considered complementary.

If the second transition does not occur before the discrepancy time elapses, the channels fault. The fault state of complementary inputs is the even-numbered input turned off and the odd-numbered input turned on. If faulted, both channel status bits are set low. When configured as a complementary dual-channel pair, the data bits for both channels are sent to the controller in complementary, or opposite states.

**Figure 7 - Complementary, Normal Operation and Fault Detection (not to scale)**



## Safety Input Fault Recovery

If an error is detected, the safety input data remains in the off state. Follow this procedure to activate the safety input data.

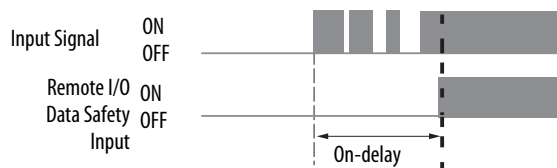
1. Remove the cause of the error.
2. Place the safety input (or safety inputs) into the safety state.

The safety input status turns on (fault cleared) after the input-error latch time has elapsed. The I/O indicator (red) turns off. The input data can now be controlled.

## Input Delays

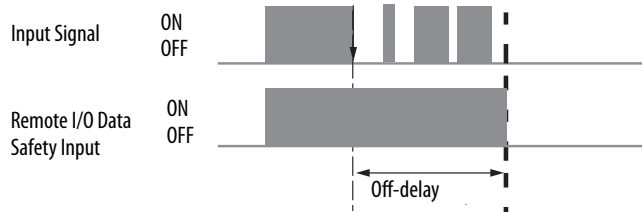
**On-delay** – An input signal is treated as logic 0 during the on-delay time (0...126 ms, in increments of 6 ms) after the rising edge of the input contact. The input only turns on if the input contact remains on after the on-delay time has elapsed. This delay helps prevent rapid changes of the input data due to contact bounce.

Figure 8 - On-delay



**Off-delay** – An input signal is treated as logic 1 during the off-delay time (0...126 ms, in increments of 6 ms) after the falling edge of the input contact. The input only turns off if the input contact remains off after the off delay time has elapsed. This delay helps prevent rapid changes of the input data due to contact bounce.

Figure 9 - Off-delay



## Muting Lamp Operation

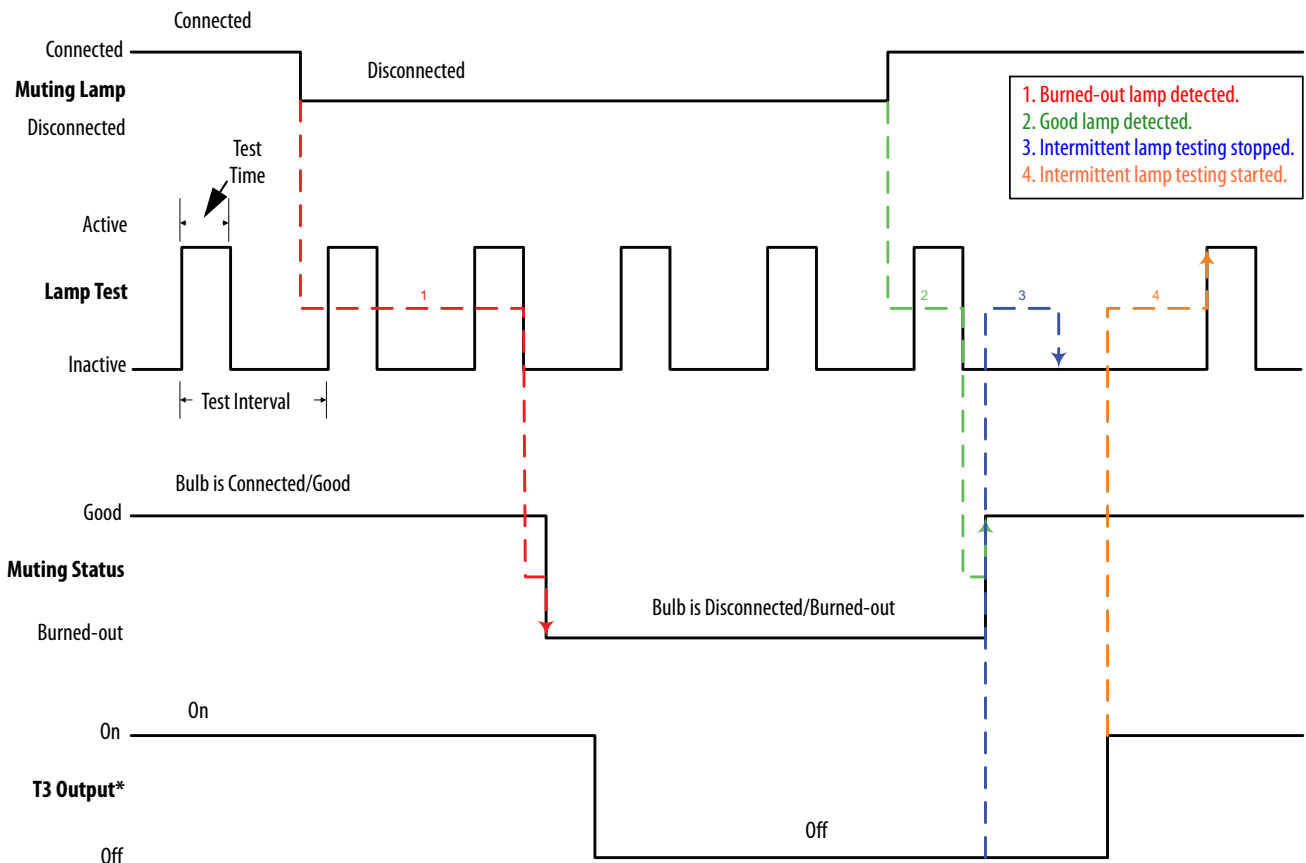
The 1732ES modules support this muting lamp feature. The feature was added to 1791ES modules in firmware revision 1.009. The operation of the muting status bits for the test outputs has changed. Your PLC processor program controls certain test outputs to illuminate a muting lamp:

- T3 and T7 for 1791ES-IB8XOBV4, 1732ES-IB8XOBV4, 1732ES-IB8XOB8
- T3, T7, and T11 for 1732ES-IB12XOB4 and 1732ES-IB12XOBV2
- T3, T7, T11, and T15 for 1791ES-IB16 and 1732ES-IB16

Muting lamp status is monitored with a test that runs periodically during every test interval to detect a burned-out lamp. The test runs repeatedly when the test output is commanded on. [Figure 10](#) explains how muting lamp operation, status, and fault detection are monitored.

**TIP** The lamp test interval is 3 seconds. Two consecutive failed lamp tests are required to declare a burned-out lamp condition. The lamp test does not run immediately after the test output is energized. It starts at the next 3-second interval. To allow time for two consecutive test intervals, program a minimum Test Output On Time of 6 seconds.

**Figure 10 - Muting Lamp Timing Diagram**



\* **IMPORTANT:** Your program controls the output, not the Muting Status bit.

Table 3 shows the expected behavior of the muting status bits. Keep these points in mind as well:

- When power is applied to the module, and a test output capable of operating as a muting output remains commanded off, the muting status defaults to on.

This bit operation is designed to help prevent erroneous muting instruction faults from the GuardLogix controller. This bit status is not the true indication of a burned-out lamp.

---

**IMPORTANT** Before checking the state of the corresponding muting status, make sure that the test output is commanded on. Once the test output is commanded on, a maximum time of 6 seconds is required for the module to detect a burned-out lamp.

---

- If a muting lamp circuit is open when power is applied to the module, the condition is detected when the test output is commanded on.
- When a lamp burns out and is replaced, the fault (muting status bit) returns to the normal condition, independent of the state of the test output.

**Table 3 - Muting Status Bit Operation**

Test Output Commanded State	Lamp Condition	Muting Status Bit	Description
ON	Bad (open circuit)	0	Repair lamp.
ON	Good	1	Normal condition. Lamp is operating properly.
OFF	Bad (open circuit)	0	If lamp remains off after a test output capable of operating as a muting output is cycled, repair the lamp.
OFF	Good	1	Normal condition.

## Safety Outputs

Read this section for information about safety outputs.



**ATTENTION:** Serious injury can occur due to the breakdown of safety outputs. Do not connect loads beyond the rated value to the safety outputs.

### Safety Output with Test Pulse

When the safety output is on, the safety output can be test pulsed, as shown in [Table 4](#) and [Figure 11](#).

**Table 4 - Safety Output Test Pulse**

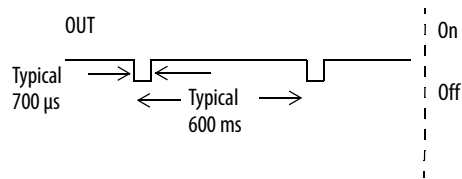
Pulse Width	Period
700 $\mu$ s	600 ms

By using this function, the following can be detected:

- Short circuits between sourcing output signal lines and the power supply (positive side)
- Short circuits between sinking output signal lines and the power supply (negative side)
- Short circuits between output signal lines of the same polarity (from sourcing output to sourcing output or from sinking output to sinking output)

If an error is detected, the safety output data and individual-safety output status turns off.

**Figure 11 - Test Pulse in a Cycle**

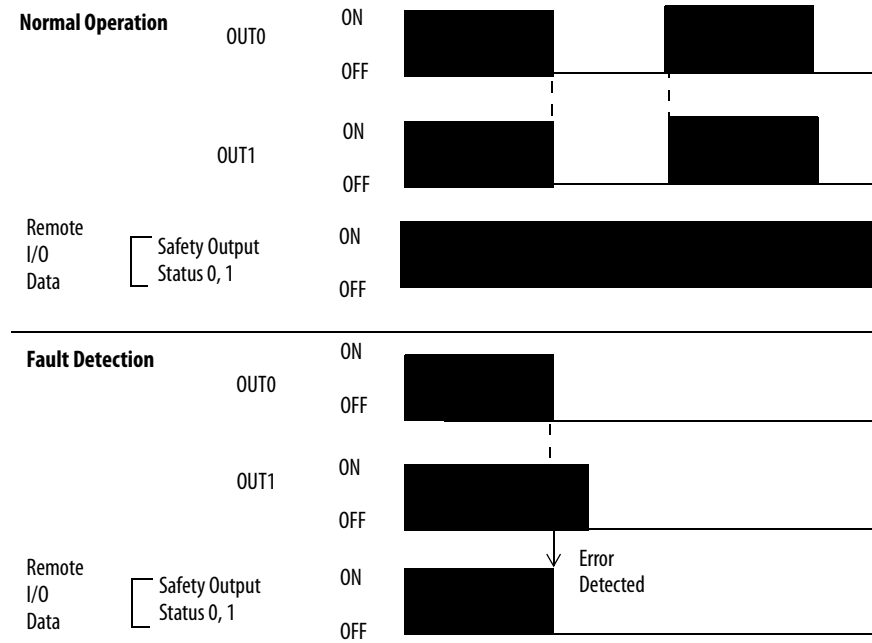


**IMPORTANT** To prevent the test pulse from causing the connected device to malfunction, pay careful attention to the input response time of the device.

## Dual-channel

When the data of both channels is in the on state, and neither channel has a fault, the outputs are turned on. The status is normal. If a fault is detected on one channel, the safety output data and individual safety output status turn off for both channels.

Figure 12 - Dual-channel (not to scale)





## Single-channel

When the data of the channel is in the on state, and the channel does not have a fault, the output is turned on. The status is normal. If a fault is detected on the channel, the safety output data and individual safety output status turn off for the channel.

**IMPORTANT** Safety outputs configured for single-channel operation must be controlled as pairs for use in functional safety applications.

**Figure 13 - Single-channel (not to scale)**



## Safety Output Fault Recovery

If a fault is detected, the safety outputs are switched off and remain in the off state.

Follow this procedure to reactivate the safety output data for modules with bipolar safety outputs (1791ES, 1732ES-IB12XOBV2, and 1732ES-IB12XOBV4 modules).

1. Remove the cause of the error.
2. Place the safety output (or safety outputs) into the safety state.

The safety output status turns on (fault cleared) when the output-error latch time has elapsed. The I/O indicator (red) turns off. The output data can now be controlled.

Safety output faults are considered critical enough to require a module power cycle to clear (a sourcing safety output channel that is shorted to output power supply positive). This condition applies to modules with sourcing-only safety outputs (only 1732ES-IB8XOB8 and 1732ES-IB12XOB4 modules).

One of these faults on any safety output channel results in all sourcing-only safety outputs being placed in the safe state (off). This condition applies to modules with sourcing-only safety outputs (only 1732ES-IB8XOB8 and 1732ES-IB12XOB4 modules).

Follow this procedure to reactivate the safety outputs after one of these faults.

1. Remove the cause of the error.
2. Power cycle the module.

The output data can now be controlled.

## Controlling Devices

See [Table 5](#) for information about controlling devices.



**ATTENTION:** Use appropriate devices as indicated in the Controlling Device Requirements table. Serious injury can occur due to loss of safety functions.

**Table 5 - Controlling Device Requirements**

Device	Requirement	Allen-Bradley® Bulletin Safety Components
Emergency stop switches	Use approved devices with direct opening mechanisms that comply with IEC/EN 60947-5-1.	Bulletin 800F, 800T
Door interlocking switches, limit switches	Use approved devices with direct opening mechanisms that comply with IEC/EN 60947-5-1 and capable of switching microloads of 24V DC 5 mA.	Bulletin 440K, 440G, 440H for interlock switch Bulletin 440P, 802T for limit switch
Safety sensors	Use approved devices that comply with the relevant product standards, regulations, and rules in the country where used.	Any Guardmaster® product
Relays with forcibly guided contacts, contactors	Use approved devices with forcibly guided contacts that comply with EN 50205. For feedback purposes, use devices with contacts capable of switching micro loads of 24V DC 5 mA.	Bulletin 700S, 100S
Other devices	Evaluate whether devices used are appropriate to satisfy the requirements of safety category levels.	—

## About the Modules

Topic	Page
Before You Begin	27
Firmware Information and Downloads	28
Functional Safety Certificates	28
Understand Suitability for Use	28
Follow Precautions for Use	30
I/O Module Overview	31
1791ES-IB16 and 1791ES-IB8XOBV4 Modules North American Hazardous Location Approval	29
Selecting a Power Supply	33
Programming Requirements	34
CIP Safety in EtherNet/IP Safety Architectures	34
Identify Major Parts of the Module	37

Read this chapter for important overview information and precautions for use for the Guard I/O™ modules that implement the EtherNet/IP safety protocol. This chapter also includes an overview on how these I/O modules are used within a safety system.

### Before You Begin

In this manual defines safety administrator as a person who is qualified, authorized, and responsible to secure safety in the design, installation, operation, maintenance, and disposal of the machine. Follow these guidelines when using a module.

- Read and understand this manual before installing and operating the module.
- Keep this manual in a safe and accessible place where personnel can refer to it when necessary.
- Use the module properly according to the installation environment, performance, and functions of the machine.
- Verify that a safety administrator conducts a risk assessment on the machine and determines module suitability before installation.

## Firmware Information and Downloads

Verify that the Guard I/O firmware revision is correct before you commission the safety system. Firmware information and downloads for safety modules are available at this link:

<http://www.rockwellautomation.com/rockwellautomation/support/pcdc.page>.

## Functional Safety Certificates

Safety certificates for Functional Safety modules are available at this link:

<http://www.rockwellautomation.com/global/certification/overview.page>

## Understand Suitability for Use

Rockwell Automation is not responsible for conformity with any standards, codes, or regulations that apply to the combination of products in your application or use of the product.

Take all necessary steps to determine the suitability of the product for the systems, machine, and equipment with which it is used.

Know and observe all prohibitions of use applicable to this product.

Never use the products for an application that involves serious risk to life or property without making sure of the following:

- The system as a whole is designed to address the risks.
- The Rockwell Automation product is properly rated and installed for the intended use within the overall equipment or system.

Use the module only in an environment that is within the general specifications of the module.

## 1791ES-IB16 and 1791ES-IB8X0BV4 Modules North American Hazardous Location Approval

The following information applies when operating this equipment in hazardous locations:

Products marked “CL I, DIV 2, GP A, B, C, D” are suitable for use in Class I Division 2 Groups A, B, C, D, Hazardous Locations and nonhazardous locations only. Each product is supplied with markings on the rating nameplate indicating the hazardous location temperature code. When combining products within a system, the most adverse temperature code (lowest “T” number) may be used to help determine the overall temperature code of the system.

Combinations of equipment in your system are subject to investigation by the local authority having jurisdiction at the time of installation.



### WARNING: EXPLOSION HAZARD

- Do not disconnect equipment unless power has been removed or the area is known to be nonhazardous.
- Do not disconnect connections to this equipment unless power has been removed or the area is known to be nonhazardous. Secure any external connections that mate to this equipment by using screws, sliding latches, threaded connectors, or other means provided with this product.
- Substitution of components may impair suitability for Class I, Division 2.
- If this product contains batteries, they must be changed only in an area known to be nonhazardous.

Informations sur l'utilisation de cet équipement en environnements dangereux: Les produits marqués “CL I, DIV 2, GP A, B, C, D” ne conviennent qu'à une utilisation en environnements de Classe I Division 2 Groupes A, B, C, D dangereux et non dangereux. Chaque produit est livré avec des marquages sur sa plaque d'identification qui indiquent le code de température pour les environnements dangereux. Lorsque plusieurs produits sont combinés dans un système, le code de température le plus défavorable (code de température le plus faible) peut être utilisé pour déterminer le code de température global du système. Les combinaisons d'équipements dans le système sont sujettes à inspection par les autorités locales qualifiées au moment de l'installation.



### WARNING: RISQUE D'EXPLOSION

- Couper le courant ou s'assurer que l'environnement est classé non dangereux avant de débrancher l'équipement.
- Couper le courant ou s'assurer que l'environnement est classé non dangereux avant de débrancher les connecteurs. Fixer tous les connecteurs externes reliés à cet équipement à l'aide de vis, loquets coulissants, connecteurs filetés ou autres moyens fournis avec ce produit.
- La substitution de composants peut rendre cet équipement inadapté à une utilisation en environnement de Classe I, Division 2.
- S'assurer que l'environnement est classé non dangereux avant de changer les piles.

## Follow Precautions for Use

Follow the precautions for use listed here and throughout this manual.

---



**ATTENTION:** Follow Safety Standards for Installation and Testing

- Use only appropriate components or devices complying with relevant safety standards corresponding to the required safety category and safety integrity level:
    - Conformity to requirements of the safety category and safety integrity level must be determined for the entire system.
    - We recommend you consult a certification body regarding assessment of conformity to the required safety integrity level or safety category.
  - You must confirm compliance with the applicable standards for the entire system.
  - Perform testing to confirm that all device configuration data and operation is correct before starting system operation.
  - After installation of the module, a safety administrator must confirm the installation and conduct trial operation and maintenance procedures.
- 



**ATTENTION:** Personnel responsible for the application of safety-related programmable electronic systems (PES) shall be aware of the safety requirements in the application of the system and shall be trained in using the system.

---



**ATTENTION:** Do not disassemble, repair, or modify the module. Any changes to the module can result in the loss of safety functions.

In case of malfunction or damage, no attempts at repair should be made. The module should be returned to the manufacturer for repair. Do not dismantle the module.

---



**ATTENTION:** Do not use EtherNet/IP standard I/O data or explicit message data as safety data.

---



**ATTENTION:** Installing or Replacing Modules

- When installing or replacing modules, clear any previous configuration before connecting the module to the network or connecting input or output power to the module.
  - When replacing a device, configure the replacement device suitably and confirm that it operates correctly.
-

## I/O Module Overview

The Guard I/O modules implement the CIP Safety™ protocol extensions over EtherNet/IP networks and provide various features for a safety system.

Use the modules to construct a safety-control network system that meets the following requirements, up to and including:

- Safety Integrity Level Claim Limit 3 (SIL CL 3), as defined in IEC 61508
- Category 4 (CAT. 4), Performance Level e (PLe), as defined in ISO 13849-1

Remote I/O communication for safety I/O data is performed through safety connections that support CIP Safety over an EtherNet/IP network, and data processing is performed in the safety controller.

A safety controller monitors the status and fault diagnostics of the I/O modules through a safety connection by using a new or existing EtherNet/IP network.

The following is a list of features common to Guard I/O modules:

- CIP Safety and EtherNet/IP protocol conformance
- Safety inputs
  - Safety devices, such as emergency stop push buttons, gate switches, and safety light curtains, can be connected.
  - Dual-channel mode evaluates consistency between two input signals (channels), which allows use of the module for Safety Category 3 and 4.
  - Single-channel evaluates one input signal (channel). This evaluation allows use of the module Safe Inputs for safety Category 2 and in applications rated up to and including Performance Level d / SIL CL2.
  - The time of a logical discrepancy between two channels can be monitored by using a discrepancy time setting.
  - An external wiring short circuit check is possible when inputs are wired in combination with test outputs.
  - Independently adjustable on and off delay is available per channel.
- Test outputs
  - Separate test outputs are provided for short circuit detection of a safety input (or inputs).
  - Power (24V) can be supplied to devices, such as safety sensors.
  - Test outputs can be configured as standard outputs.
  - All Guard I/O modules have numerous test outputs, of which some can be used for broken wire detection of a muting lamp.
- Safety outputs
  - Dual-channel mode evaluates consistency between two output signals (channels).
  - Safety outputs can be pulse tested to detect field wiring shorts to 24V DC and 0V DC.
- I/O status data – The module includes status data for monitoring I/O circuits and I/O data.
- Removable I/O connectors (only 1791ES modules) – I/O connectors support mechanical keying.
- Network address translation (NAT) support – Available in Logix Designer version 24 or later, NAT is a service that translates one IP address to another IP address via a NAT-configured switch. The switch translates the source and destination addresses within data packets as traffic passes between subnets. This service is useful if you must reuse IP addresses throughout a network. For example, with NAT, you can segment devices that share one IP address on a private subnet into multiple identical private subnets while maintaining unique identities on the public subnet.

See [Table 6](#) for a description of the Guard I/O modules.



**Table 6 - Guard I/O Module Descriptions**

Catalog Number	Description	Enclosure Type Rating	Safety Inputs	Test Outputs <sup>(1)</sup>	Safety Outputs (solid-state)
1791ES-IB16	CompactBlock™ safety input module	Meets IP20	16	16	—
1791ES-IB8X0BV4	CompactBlock safety I/O module with solid-state outputs		8	8	8 bipolar outputs (4 pairs)
1732ES-IB12X0B4	ArmorBlock® safety I/O module with solid-state outputs	Meets IP65/IP67 (when marked)	12	12	4 sourcing outputs
1732ES-IB12X0BV2	ArmorBlock safety I/O module with solid-state outputs		12	12	4 bipolar outputs (2 pairs)
1732ES-IB16	ArmorBlock safety input module	Meets IP65/IP67 (when marked)	16	16	—
1732ES-IB8X0B8	ArmorBlock safety I/O module with solid-state outputs	Meets IP65/IP67 (when marked)	8	8	8 sourcing outputs
1732ES-IB8X0BV4	ArmorBlock safety I/O module with solid-state outputs	Meets IP65/IP67 (when marked)	8	8	8 bipolar outputs (4 pairs)

(1) Broken wires can be detected on the muting outputs.

## Selecting a Power Supply

For CE LVD compliance, verify that the external power supply that provides power to the modules is safety extra low voltage (SELV) rated. Some Rockwell Automation® Bulletin 1606 power supplies are SELV-compliant. See Switched Mode Power Supply Specifications Technical Data, publication [1606-TD002](#), and the installation instructions for the modules.



### **ATTENTION:** Prevent Electric Shock

To prevent electric shock, use a DC power supply that meets the following requirements:

- A DC power supply with double or reinforced insulation; for example, according to IED/EN 60950, or EN 50178, or a transformer according to IEC/EN 61558.
- A DC power supply satisfies requirement for class 2 circuits or limited voltage/current circuit stated in UL 508.
- An external power supply that is safety extra-low voltage (SELV) rated.



### **ATTENTION:** Do Not Exceed Specified Voltage

- Do not apply DC voltages exceeding the rated voltages to the module.
- Apply properly specified voltages to the module inputs. Applying inappropriate voltages causes the module to fail to perform its specified function, which leads to loss of safety functions or damage to the module.

## Programming Requirements

Use the minimum software versions listed here.

Cat. No.	Studio 5000 Logix Designer® Version <sup>(1)</sup>	RSLogix 5000® Software Version <sup>(1)</sup> (EtherNet/IP Network)
1791ES-IB16	21	16
1791ES-IB8XOBV4		
1732ES-IB12XOB4		
1732ES-IB12XOBV2		
1732ES-IB16	18	
1732ES-IB8XOB8		
1732ES-IB8XOBV4		

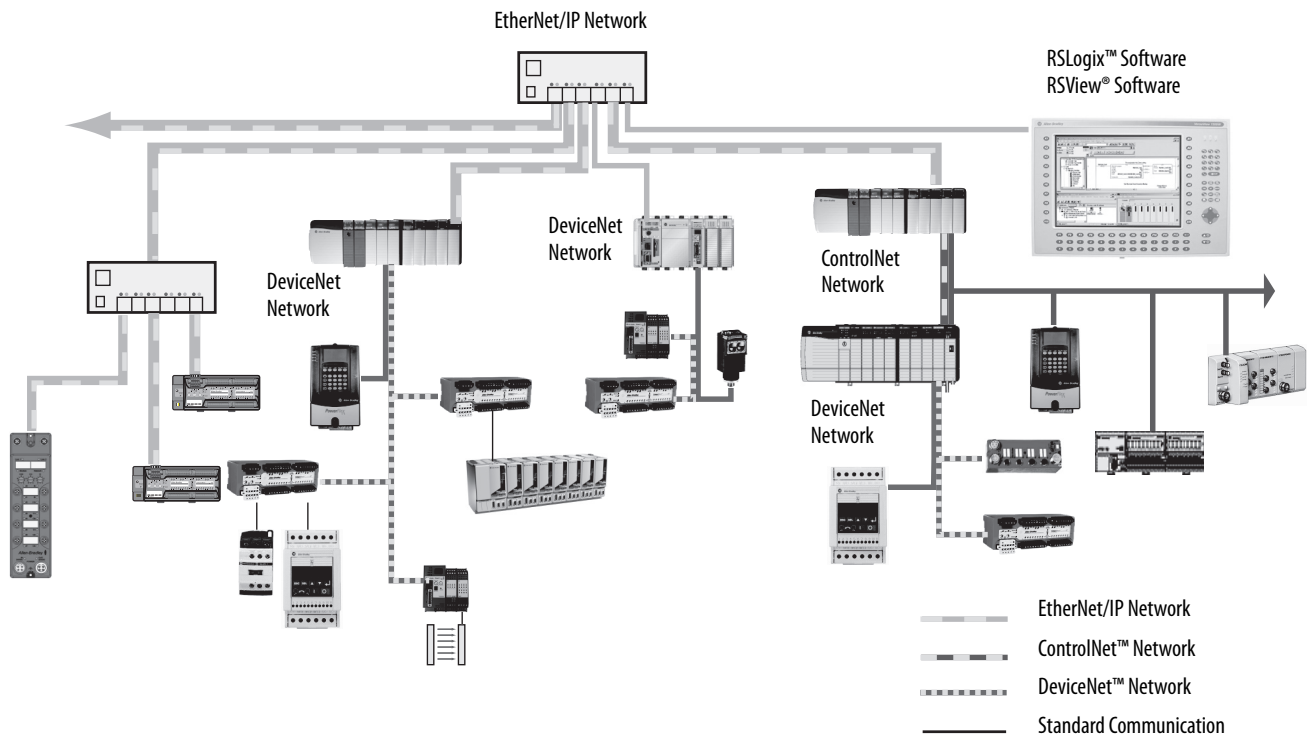
(1) This version or later.

## CIP Safety in EtherNet/IP Safety Architectures

Safety controllers control the safety outputs. Safety or standard controllers can control the standard outputs. Use Guard I/O modules in EtherNet/IP safety architectures as shown in [Figure 14](#). The Guard I/O family is a set of I/O modules that when connected to an EtherNet/IP safety network are suitable for applications up to and including:

- SIL CL 3 as defined in IEC 61508
- CAT. 4, PLe, as defined in ISO 13849-1

**Figure 14 - Safety Interlocking and Control Via CIP Safety (linear and star topology)**



## Device Level Ring (DLR)

A DLR network is a single-fault-tolerant ring network that is intended for the interconnection of automation devices without the need for more switches.

The ring topology offers these advantages:

- Media redundancy
- Fast-network fault detection and reconfiguration
- Resiliency of a single-fault-tolerant network
- Easy implementation without more hardware requirements

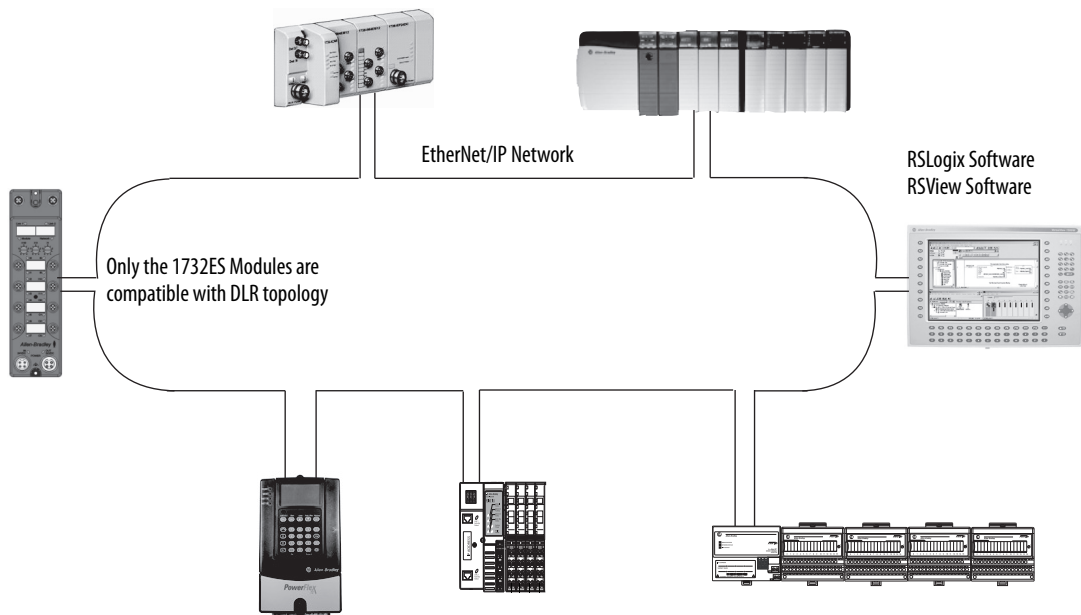
---

**IMPORTANT** This section summarizes a DLR network. To plan, configure, and monitor DLR networks, see *EtherNet/IP Embedded Switch Technology Application Guide*, publication [ENET-AP005](#).

---

One DLR network can support as many as 50 nodes. A DLR network supports copper connections (maximum of 100 m), fiber-optic connections (maximum of 2 km), or a mix of copper and fiber.

**Figure 15 - Safety Interlocking and Control Via CIP Safety (DLR topology) Only 1732ES Modules**




---

**IMPORTANT** Only one DLR ring is supported per active Stratix® 5700 switch.

---

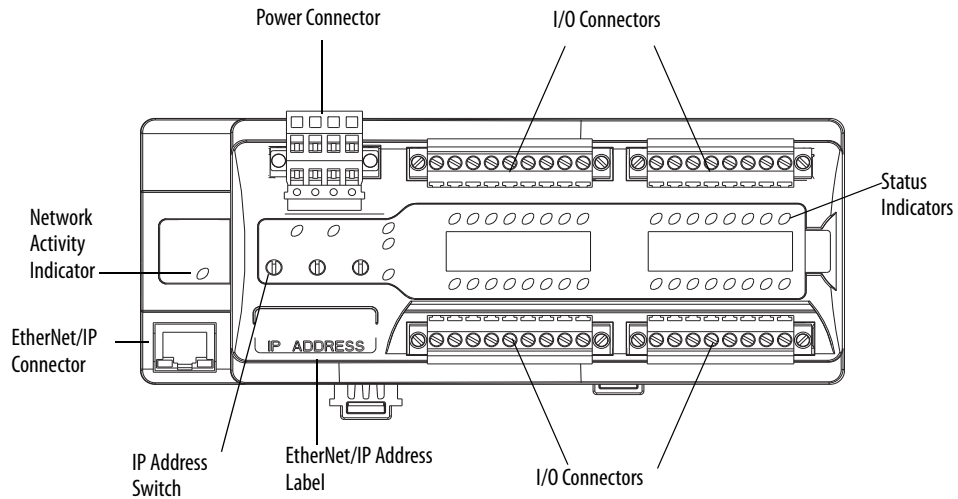
A DLR network includes the following nodes.

Node	Description
Supervisor node	<p>A DLR network requires at least one node to be configured as ring supervisor.</p> <p><b>IMPORTANT:</b> By default, the supervisor function is disabled on supervisor-capable devices, so they are ready to participate in a linear/star network or as a ring node on a DLR network.</p> <p>In a DLR network, you must configure at least one of the supervisor-capable devices as the ring supervisor before physically connecting the ring. If you do not, the DLR network does not work.</p> <p>The ring supervisor provides these main functions:</p> <ul style="list-style-type: none"> <li>• Manages traffic on the DLR network</li> <li>• Collects diagnostic information for the network</li> </ul> <p>We recommend that you do the following:</p> <ul style="list-style-type: none"> <li>• Configure at least one back-up supervisor.</li> <li>• Configure the desired active ring supervisor with a numerically higher precedence value as compared to the back-up supervisors.</li> <li>• Track the supervisor-precedence values for all supervisor-enabled nodes in the DLR network.</li> </ul>
Ring node	<p>A ring node is any node that operates on the network to process data that is transmitted over the network. A ring node can also pass on the data to the next node on the network. When a fault occurs on the DLR network, the ring nodes reconfigure themselves and relearn the network topology. Additionally, ring nodes can report fault locations to the active ring supervisor.</p>

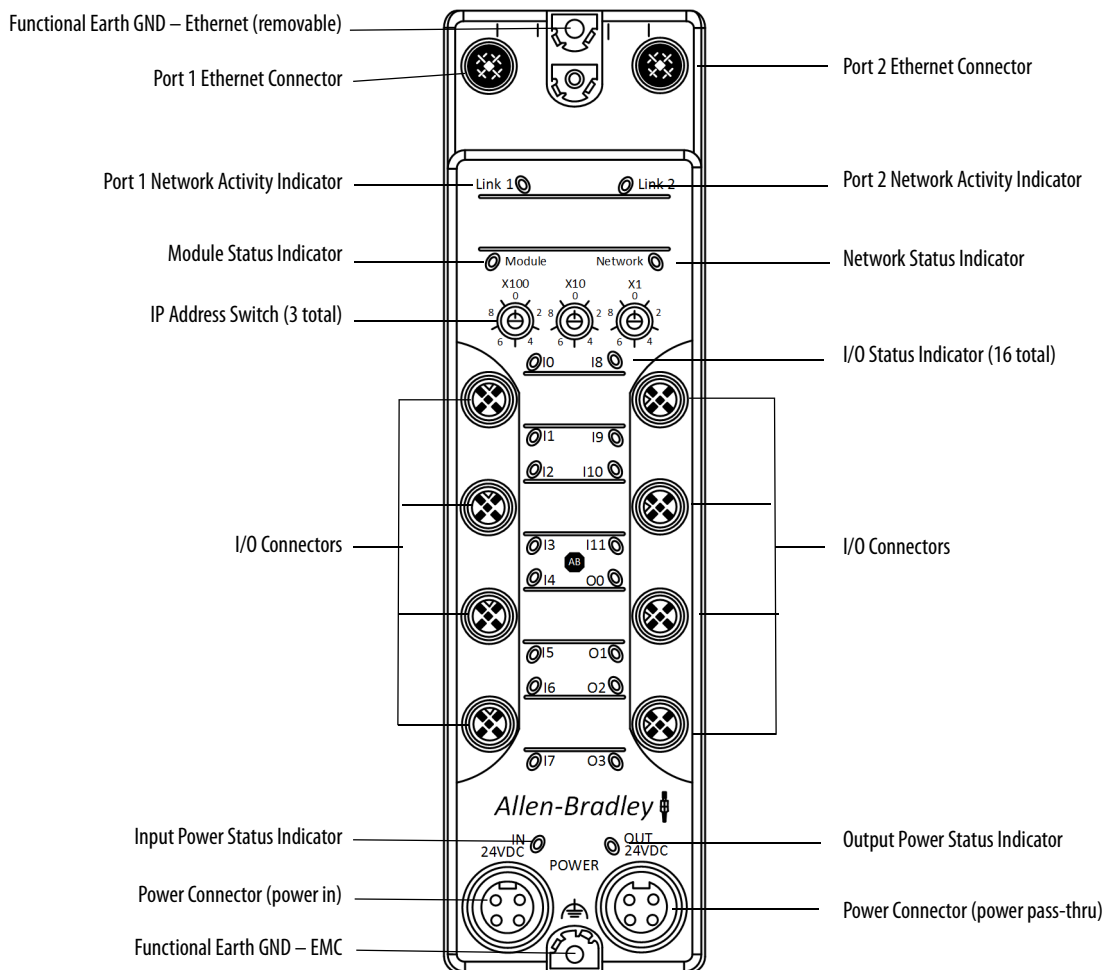
## Identify Major Parts of the Module

See [Figure 16](#) and [Figure 17](#) for module identification. See [Chapter 3](#) for pinout information.

**Figure 16 - 1791ES Module Connections and Indicators**



**Figure 17 - 1732ES Module Connection and Indicators**



**Notes:**

## Install the Module

Topic	Page
Environment and Enclosure	39
Prevent Electrostatic Discharge	41
Environmental Considerations for Use	42
Follow Wiring Precautions	42
Follow DC Power Supply Precautions	45
Mount the Module	45
Make Connections for 1791ES Modules	52
Make Connections for 1732ES Modules	55

Read and understand this section before you begin to install the module.

### Environment and Enclosure

#### For 1791ES Modules



**ATTENTION:** This equipment is intended for use in a Pollution Degree 2 industrial environment, in overvoltage Category II applications (as defined in IEC 60664-1), at altitudes up to 2000 m (6562 ft) without derating.

This equipment is not intended for use in residential environments and may not provide adequate protection to radio communication services in such environments.

This equipment is supplied as open-type equipment for indoor use. It must be mounted within an enclosure that is suitably designed for those specific environmental conditions that will be present and appropriately designed to prevent personal injury resulting from accessibility to live parts. The enclosure must have suitable flame-retardant properties to prevent or minimize the spread of flame, complying with a flame spread rating of 5VA, or be approved for the application if non-metallic. The interior of the enclosure must be accessible only by the use of a tool. Subsequent sections of this publication may contain additional information regarding specific enclosure type ratings that are required to comply with certain product safety certifications.

In addition to this publication, see the following:

- Industrial Automation Wiring and Grounding Guidelines, publication [1770-4.1](#), for more installation requirements.
- NEMA Standard 250 and EN/IEC 60529, as applicable, for explanations of the degrees of protection provided by enclosures.



**ATTENTION:** 1791ES modules are certified for use only within the surrounding air temperature range of -20...+60 °C (-4...+140 °F). The 1791ES modules must not be used outside of this range.

---



**WARNING:** Do not replace components or disconnect equipment unless power has been switched off or the area is known to be free of ignitable concentrations.

---

### For 1732ES Modules



This equipment is intended for use in overvoltage Category II applications (as defined in IEC 60664-1), at altitudes up to 2000 m (6562 ft) without derating.

This equipment is not intended for use in residential environments and may not provide adequate protection to radio communication services in such environments.

This equipment is supplied as enclosed equipment. It should not require additional system enclosure when used in locations consistent with the enclosure type ratings stated in the Specifications section of this publication. Subsequent sections of this publication may contain more information regarding specific enclosure type ratings, beyond what this product provides, that are required to comply with certain product safety certifications.

In addition to this publication, see the following:

- Industrial Automation Wiring and Grounding Guidelines, publication [1770-4.1](#), for more installation requirements.
  - NEMA Standard 250 and EN/IEC 60529, as applicable, for explanations of the degrees of protection provided by enclosures.
- 



**ATTENTION:** All 1732ES modules EXCEPT the 1732ES-IB16 module are certified for use only within the surrounding air temperature range of -20...+55 °C (-4...+131 °F). All 1732ES modules EXCEPT the 1732ES-IB16 modules must not be used outside of this range. The 1732ES-IB16 module is certified for use only within the surrounding air temperature range of -20...+60 °C (-4...+140 °F). The 1732ES-IB16 module must not be used outside of this range.

---



## Prevent Electrostatic Discharge



**ATTENTION:** This equipment is sensitive to electrostatic discharge, which can cause internal damage and affect normal operation. Follow these guidelines when you handle this equipment:

- Touch a grounded object to discharge potential static.
- Wear an approved grounding wriststrap.
- Do not touch connectors or pins on component boards.
- Do not touch circuit components inside the equipment.
- Use a static-safe workstation, if available.
- Use only a soft dry anti-static cloth to wipe down equipment. Do not use any cleaning agents.
- Store the equipment in appropriate static-safe packaging when not in use.

## Environmental Considerations for Use

Do not use the module in locations that are subject to these conditions:

- Direct sunlight
- Temperatures or humidity beyond the ranges noted in [Specifications on page 161](#)
- Condensation as the result of severe changes in temperature
- Corrosive or flammable gases
- Dust, especially iron dust (only 1791ES modules)
- Salts
- Water (only 1791ES modules)
- Oil or chemicals
- Shock or vibration beyond the range noted in [Specifications on page 161](#)

Do not clean the modules with these materials:

- Acetone
- Benzene
- Thinner

## Follow Wiring Precautions



### **WARNING:** Connecting and Disconnecting Wiring and Cables

- When you connect or disconnect the removable terminal block (RTB) or power cables with field-side power applied, an electrical arc can occur. This could cause an explosion in hazardous location installations. Be sure that power is removed or the area is nonhazardous before proceeding.
  - If you connect or disconnect wiring or cables while the field-side power is on, an electrical arc can occur. This could cause an explosion in hazardous location installations. Be sure that power is removed or the area is nonhazardous before proceeding.
  - If you connect or disconnect the communication cables with power applied to this module or any device on the network, an electrical arc can occur. This could cause an explosion in hazardous location installations.
-

**ATTENTION: Wiring Guidelines**

- Disconnect the module from the power supply before wiring or connecting cables. Devices connected to the module can operate unexpectedly if wiring is performed while power is supplied.
  - Wire correctly after confirming the signal names of all terminals.
  - Wire the Guard I/O™ modules properly so that 24V DC line does not touch the safety outputs accidentally or unintentionally.
  - Do not route communication, input, or output wiring with conduit containing high voltage. Refer to Industrial Automation Wiring and Grounding Guidelines, publication [1770-4.1](#).
  - Wire conductors correctly and verify operation of the module before placing the system into operation. Incorrect wiring can lead to loss of safety function.
- 

**ATTENTION: Be Aware of Safety Requirements**

Personnel responsible for the application of safety-related programmable electronic systems (PES) shall be aware of the safety requirements in the application of the system and shall be trained in using the system.

---

**ATTENTION: Electrical Safety Considerations**

To comply with the CE Low Voltage Directive (LVD), all connections to this equipment must be powered from a source compliant with the following:

- Safety Extra Low Voltage (SELV) Supply.
- Protected Extra Low Voltage (PELV) Supply.

If the devices (sensors) connected to the input connections require Class 2 power to operate, the auxiliary power connections of this equipment must be powered by a Class 2 source.

---

**ATTENTION: Maintain IP Rating for 1732ES Modules**

Make sure all connectors and caps on 1732ES modules are securely tightened to properly seal the connections against leaks and maintain IP enclosure type requirements.

Applicable only to 1732ES modules.

---



---

**ATTENTION:** You can configure Test Outputs to be used as standard outputs. You can connect actuators to Test Output points that are expecting a Standard configuration.

Test Output points configured as Pulse Test or Power Supply become active whenever you apply input power to the module. These configured functions are independent of the I/O connections to the module.

---



---

**ATTENTION:** If a module with Test Outputs configured as Pulse Test or Power Supply is incorrectly installed in an application where actuators are connected to these Test Output points, the actuators are activated when input power is applied.

To prevent this possibility, follow these procedures.

- When installing a module, be sure that the module is correctly configured for the application or in the out-of-box condition before applying input power.
  - When replacing a module, be sure that the module is correctly configured for the application or in the out-of-box condition before applying input power.
  - Reset modules to their out-of-box condition when removing them from an application.
  - Be sure that all modules in replacement stock are in their out-of-box condition.
-

## Follow DC Power Supply Precautions



**ATTENTION:** To prevent electric shock, use a DC power supply that meets these requirements:

- A DC power supply with double or reinforced insulation, for example, according to IED/EN 60950 or EN 50178 or a transformer according to IEC/EN 61558.
- A DC supply satisfies requirement for class 2 circuits or limited voltage/current circuit stated in UL 508.
- Use an external power supply that is safety extra-low voltage (SELV) rated.
- Follow these precautions for safe use.
- Wire conductors correctly and verify operation of the module before placing the system into operation. Incorrect wiring can lead to loss of safety function.
- Do not apply DC voltages exceeding the rated voltages to the module.
- Apply properly specified voltages to the module inputs. Applying inappropriate voltages causes the module to fail to perform its specified function, which leads to loss of safety functions or damage to the module.
- Never use test outputs as safety outputs. Test outputs are not safety outputs.
- Note that after installation of the module, a safety administrator must confirm the installation and conduct trial operation and maintenance.
- Do not disassemble, repair, or modify the module. This can result in loss of safety functions.
- Use only appropriate components or devices complying with relevant safety standards corresponding to the required safety category and safety integrity level.
  - Conformity to requirements of the safety category and safety integrity level must be determined for the entire system.
  - We recommend you consult a certification body regarding assessment of conformity to the required safety integrity level or safety category.
- Note that you must confirm compliance with the applicable standards for the entire system.
- Disconnect the module from the power supply before wiring. Devices connected to the module can operate unexpectedly if wiring is performed while power is supplied.

## Mount the Module

Follow these guidelines to mount the module:

- Modules can be mounted horizontally or vertically.
- Do not mount the module near any heat source that can increase the operating temperature of the module.
- 1732ES modules meet IP65/IP67 (when marked).
- Mount catalog number 1791ES-IB16 and 1791ES-IB8XOBV4 modules in an enclosure rated IP54 (IEC60529) or higher.

### Module Spacing

Leave minimum spacing to the wiring duct or other objects for adequate ventilation and room for wiring.

**Figure 18 - Required Spacing for 1791ES-IB16 and 1791ES-IB8X0BV4 Modules**

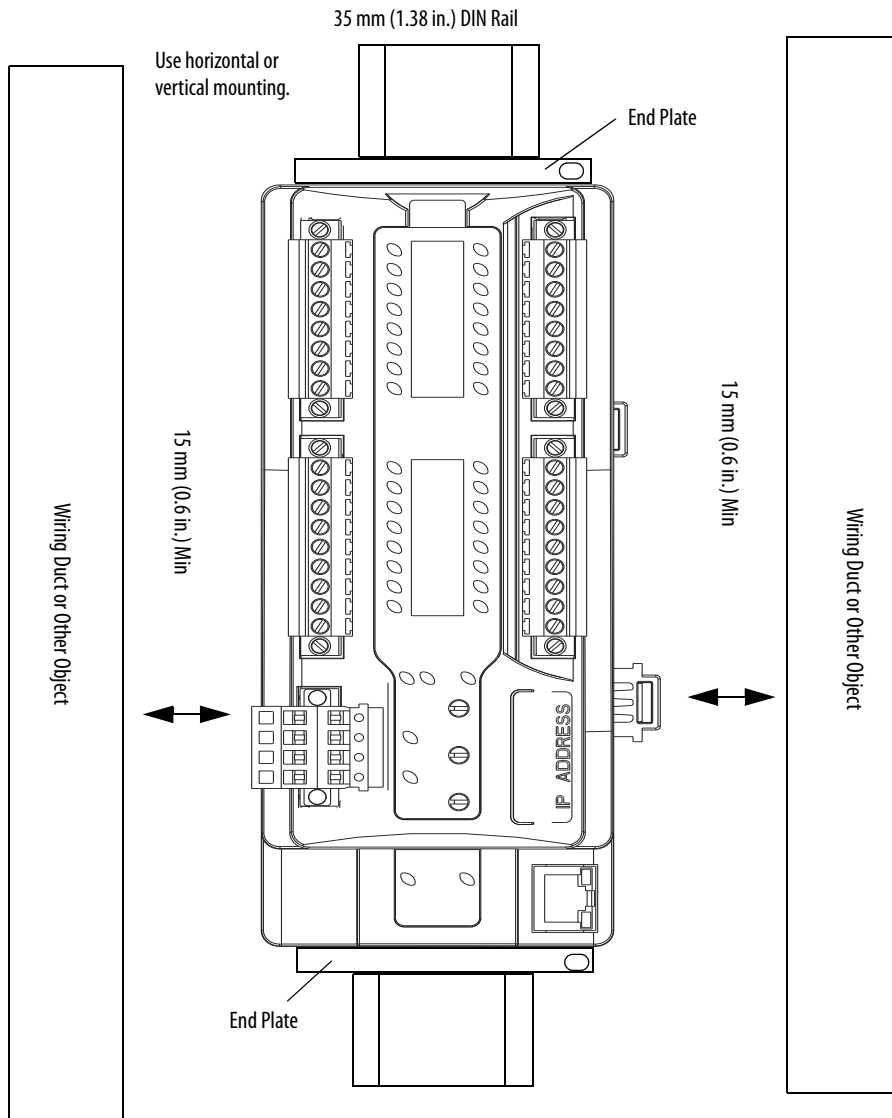
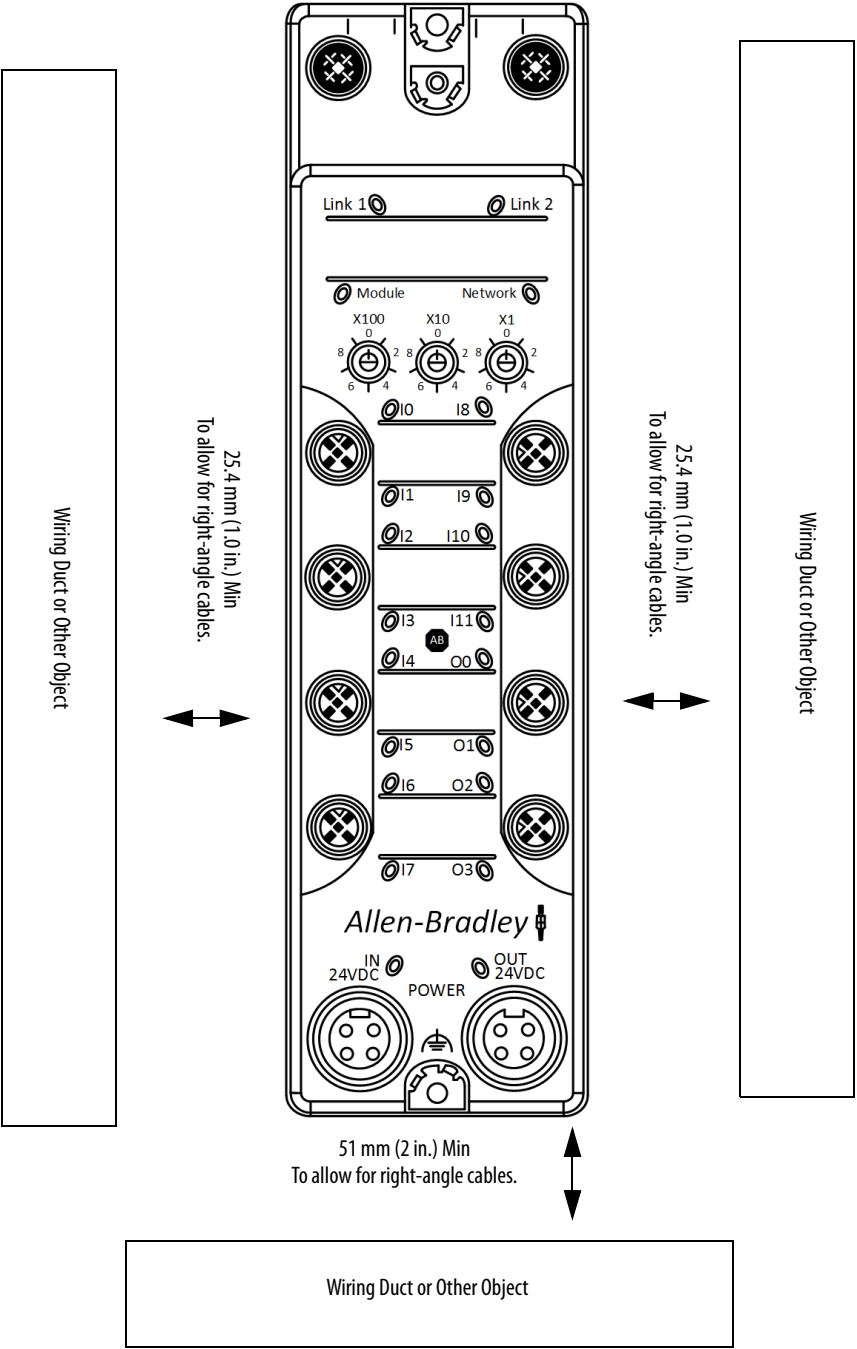


Figure 19 - Required Spacing for 1732ES Modules

Use horizontal or vertical mounting.

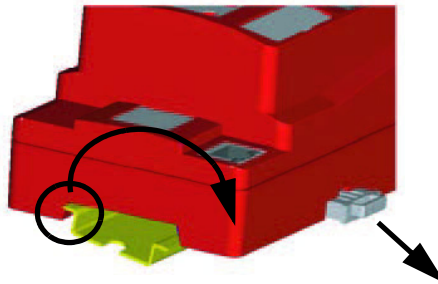


## Mount the 1791ES Modules on a DIN Rail

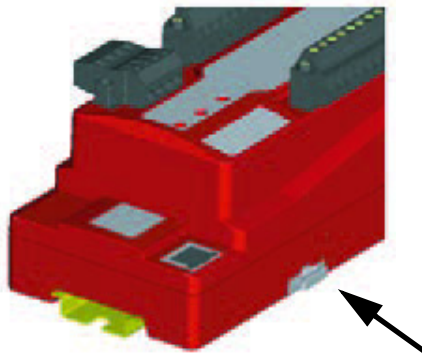
Use a DIN rail that is 35 mm (1.38 in.) wide to install the module in the control panel. Secure the 35 mm (1.4 in.) DIN rail properly with fasteners every 200 mm (7.87 in.). Use an end plate on each end of the module to secure it to the DIN rail.

Follow these steps to mount the module on a DIN rail.

1. To lock them in the open position, pry open the two gray latches.
2. Hook the module over the top of the DIN rail.



3. Rotate the module down until it makes full contact with the DIN rail.
4. To secure the module to the rail, snap the latches back into place.



5. Verify that the module is securely attached to the DIN rail.

### Grounding



**ATTENTION:** This product is grounded through the DIN-rail-to-chassis ground. Use zinc plated yellow-chromate steel DIN rail to assure proper grounding. The use of other DIN rail materials (for example, aluminum and plastic) that can corrode, oxidize, or are poor conductors, can result in improper or intermittent grounding. Secure the DIN rail to the mounting surface approximately every 200 mm (7.87 in.) and use end plates to secure it to the DIN rail.

---



## Mount the 1732ES Modules on a Wall or Panel

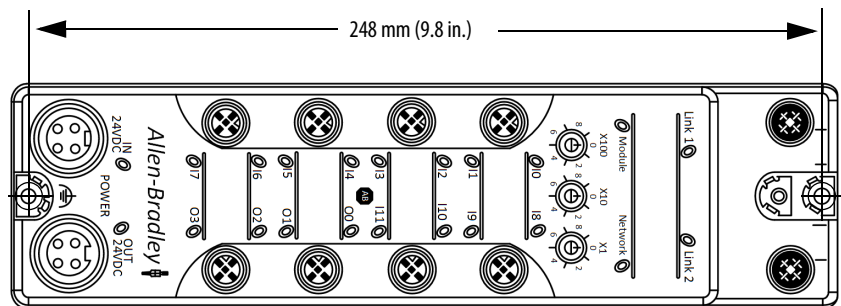
To mount the module on a wall or panel, use the screw holes provided in the module.



**ATTENTION:** To meet safety and EMC requirement this module must be mounted on a flat conductive and fireproof surface.

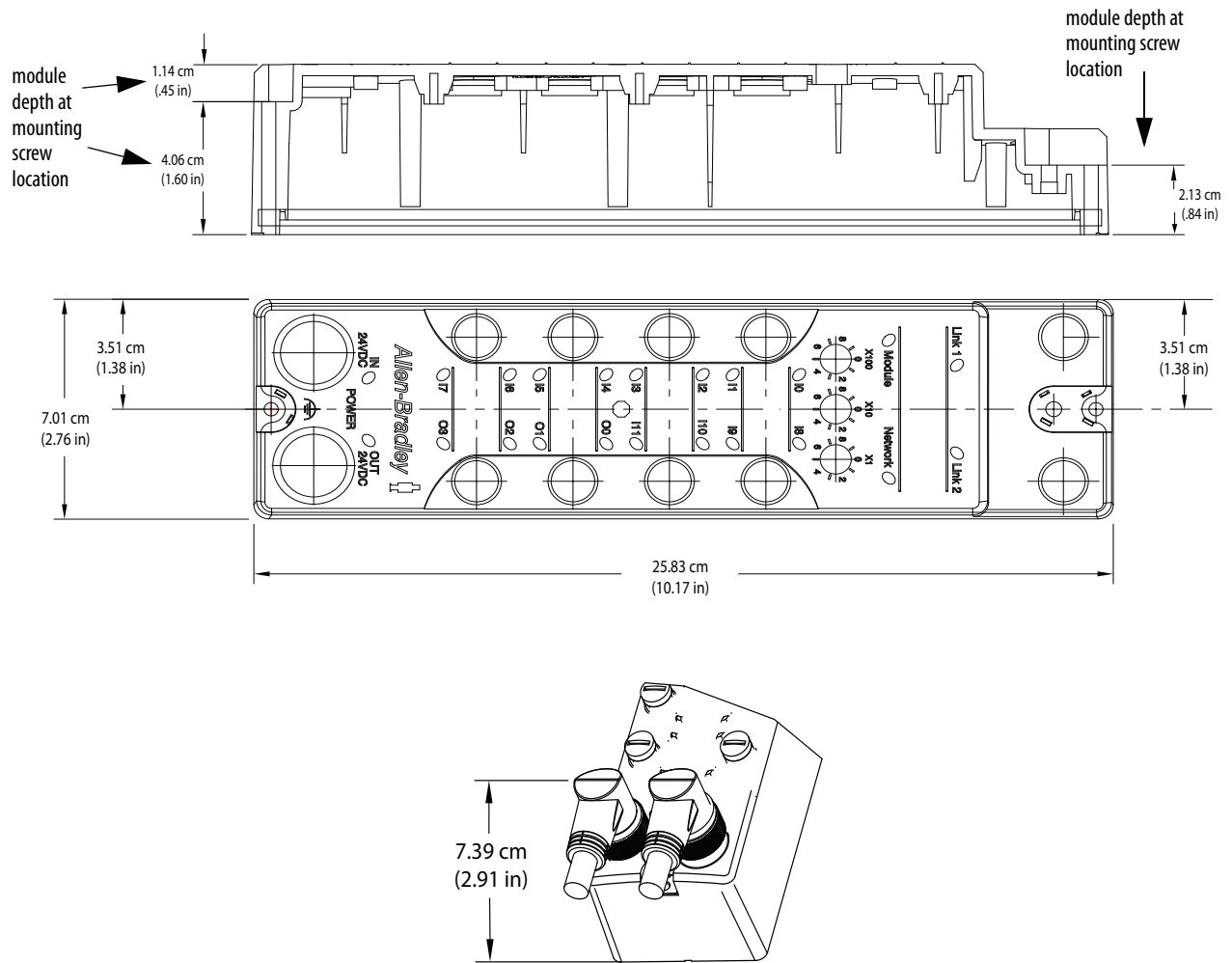
Follow these steps to mount the module.

1. To lay out the drill locations, use the mounting holes in the module as a guide.
2. Mark the center of drill location with a pencil or marker.



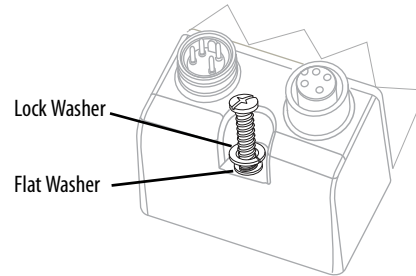
3. Use a center punch to mark the drill locations.
4. Use a 4.5 mm (0.177 in.) drill to make the pilot holes.
5. Mount the module with two #8 (M4) screws.

Figure 20 - 1732ES Module Physical Dimensions



### Mount the Module in High Vibration Areas

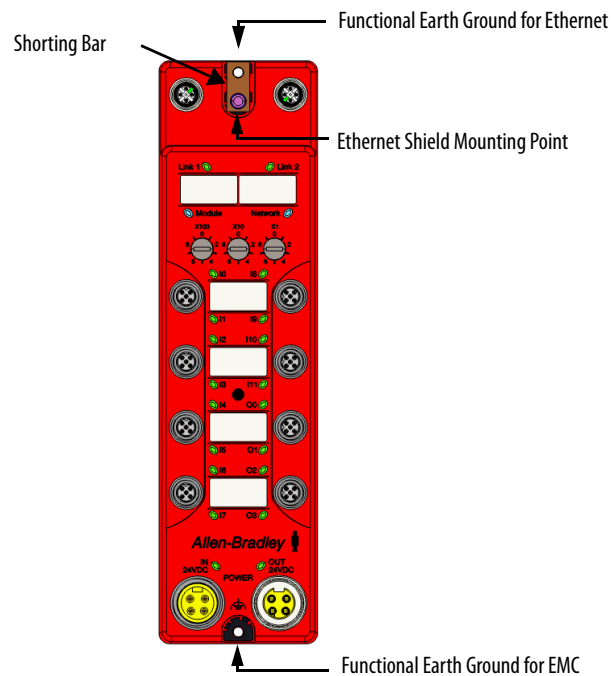
If you mount the module in an area that is subject to shock or vibration, use a flat washer and a lock washer to mount the module.



Torque the mounting screws to 0.68 N•m (6 lb•in.).

### Grounding the 1732ES Modules

This figure shows the grounding features for the 1732ES modules.



#### Functional Earth Ground for Ethernet

The mounting screw at the top of the module is for the complex Ethernet shield grounding features. The rectangular 'shorting' bar is held in place by a conductive screw/washer combination that connects electrically to the metal shields of the Ethernet connectors internal to the module.

To ground the Ethernet shields at the module, leave the factory-installed 'shorting' bar with the conductive screw/washer combination in place. You

must also mount the module to an earth-grounded, conductive surface with conductive mounting hardware.

If you do not want to ground the Ethernet shields at the module, remove the ‘shorting’ bar and conductive screw/washer combination and mount the module to wall or panel.

**TIP** If the Ethernet shields are not grounded at the module, the mounting screw at the Ethernet end of the module is not required to make a connection with earth ground.

*Functional Earth Ground for EMC*

The mounting screw at the bottom of the module is required to be a conductive screw for EMC compliance. Mount the module to an earth-grounded, conductive surface by using conductive mounting hardware to make the required connection with earth ground.

## Make Connections for 1791ES Modules

Follow these guidelines when wiring the module:

- For stranded wire, install an insulation-covered ferrule (DIN 46228-4 standard compatible-type) at the ends before you connect wires.
- Torque screws for the power connector to 0.56...0.79 N•m (5...7 lb•in).
- Torque screws for the I/O connectors to 0.5...0.56 N•m (4.5...5 lb•in).

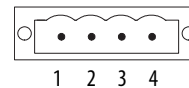
See the Ethernet Design Considerations Reference Manual, publication [ENET-RM002](#), for information about Ethernet cable.

## Power Connections

See [Table 7](#) for a description of the pins in the power connector.

**Table 7 - Power Connector Pin Descriptions**

Pin No.	Signal
1	Input +24V DC power
2	Input power common
3	Output +24V DC power <sup>(1)</sup>
4	Output power common <sup>(1)</sup>



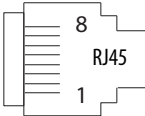
(1) NC on catalog number 1791ES-IB16 modules.

### EtherNet/IP Connections

See [Table 8](#) for a description of the pins in the EtherNet/IP connector.

**Table 8 - EtherNet/IP Connector Pin Descriptions**

Pin No.	Signal
8	No connection
7	No connection
6	Receive data minus
5	No connection
4	No connection
3	Receive data plus
2	Transmit data minus
1	Transmit data plus



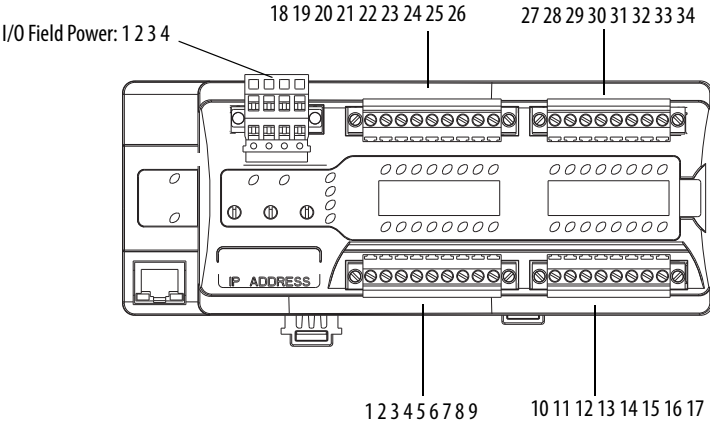
### I/O Connections

For wiring diagrams, see [Wiring Examples on page 63](#).

**IMPORTANT** Because the I/O connector has a structure that helps prevent incorrect wiring, make connections at the specified locations that correspond to the terminal numbers.

See [Figure 21](#) for a description of the pins in the I/O connector.

**Figure 21 - I/O Connector Pin Descriptions**



**Table 9 - Terminal Positions for I/O Field Power**

Terminal No.	Signal	Terminal No.	Signal
1	Input +24V DC	3	Output +24V DC <sup>(1)</sup>
2	Input -24V DC	4	Output -24V DC <sup>(1)</sup>

(1) Applies only to catalog number 1791ES-IB8X0BV4 module.

**Table 10 - Terminal Positions for Terminal Numbers 1...18**

Terminal No.	Signal	Terminal No.	Signal
1	Functional earth	10	Safety input 4
2	Safety input 0	11	Safety input 5
3	Safety input 1	12	Test output 4
4	Test output 0	13	Test output 5
5	Test output 1	14	Safety input 6
6	Safety input 2	15	Safety input 7
7	Safety input 3	16	Test output 6
8	Test output 2	17	Test output 7/muting
9	Test output 3/muting	18	Functional earth

**Table 11 - Terminal Positions for Numbers 19...34**

Terminal No.	Signal	
	Cat. No. 1791ES-IB8XOBV4 Module	Cat. No. 1791ES-IB16 Module
19	Safety output 0 <sup>(1)</sup> /switch +24V DC	Safety input 8
20	Safety output 1 <sup>(1)</sup> /switch 24V DC common	Safety input 9
21	L-/24V DC common	Test output 8
22	S+/24V DC	Test output 9
23	Safety output 2 <sup>(2)</sup> /switch +24V DC	Safety input 10
24	Safety output 3 <sup>(2)</sup> /switch 24V DC common	Safety input 11/muting
25	L-/24V DC common	Test output 10
26	S+/24V DC	Test output 11
27	Safety output 4 <sup>(3)</sup> /switch +24V DC	Safety input 12
28	Safety output 5 <sup>(3)</sup> /switch 24V DC common	Safety input 13
29	L-/24V DC common	Test output 12
30	S+/24V DC	Test output 13
31	Safety output 6 <sup>(4)</sup> /switch +24V DC	Safety input 14
32	Safety output 7 <sup>(4)</sup> /switch 24V DC common	Safety input 15
33	L-/24V DC common	Test output 14
34	S+/24V DC	Test output 15/muting

- (1) Safety outputs 0/1 must be controlled as a pair.
- (2) Safety outputs 2/3 must be controlled as a pair.
- (3) Safety outputs 4/5 must be controlled as a pair.
- (4) Safety outputs 6/7 must be controlled as a pair.

## Make Connections for 1732ES Modules

See the Ethernet Design Considerations Reference Manual, publication [ENET-RM002](#), for information about Ethernet cable.

### Power Connections

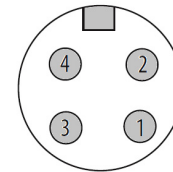
This section describes the power connectors and recommended cables.

**Table 12 - Power Connector Pin Description**

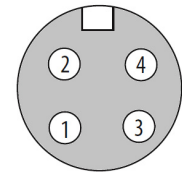
Pin No.	Signal
1	Output +24V DC power <sup>(1)</sup>
2	Input +24V DC power
3	Input power, common
4	Output power, common <sup>(1)</sup>

(1) Not required for 1732ES-IB16 modules.

Male Input  
(mates to female cable end)



Female Output  
(mates to male cable end)



**Table 13 - Recommended Power Cables**

Description	Cat. No.
Mini right angle female to flying leads cord set	889N-R4AFC-6F <sup>(1)</sup>
Mini straight female to flying leads cord set	889N-F4AFC-6F <sup>(1)</sup>
Mini right angle male to flying leads cord set	889N-E4AFC-6F <sup>(1)</sup>
Mini straight male to flying leads cord set	889N-M4AFC-6F <sup>(1)</sup>
Mini right angle male to right angle female patch cord	889N-R4AFNE-2 <sup>(2)</sup>
Mini straight male to straight female patch cord	889N-F4AFNM-2 <sup>(2)</sup>

(1) Replace -6F (1.8 m [6 ft]) with -12 (3.7 m [12 ft]) or -20 (6.1 m [20 ft]) for additional standard cable lengths.

(2) Replace -2 (2 m [6.6 ft]) with -5 (5 m [16.4 ft]) or -10 (10 m [32.8 ft]) for additional standard cable lengths.

See <http://www.ab.com/en/epub/catalogs/6005557/6005561/10508712/10513424/10513435/Introduction.html> for more information.

### Power Pass Through

The power that the module requires is supplied via a 4-pin mini-style connector system. The module receives its required power through the male connector on the left. A female connector on the right is also provided so that power can be daisy chained from module to module.

---

**IMPORTANT** Use power pass through (daisy chaining of power) only for 'de-energize to trip' (safety state = OFF) applications.

---

Most 1732ES modules require two 24V DC (nominal) supplies. These supplies are called the 'input +24V DC power' and the 'output +24V DC power'. The input +24V DC power provides power for the module control and Ethernet portions of the module, the safety input/test output circuits, and the test output loads. The output +24V DC power provides power for the safety output circuits and the safety output loads. Since the 1732ES-IB16 module has no safety outputs, it requires only one 24V DC (nominal) power supply to provide 'input +24V DC power'.

Internally, the input +24V DC power and output +24V DC power are isolated from each other.

---

**IMPORTANT** The maximum current that any pin on the power connectors can carry is 10 A.

---

The input +24V DC power current that is required for a module in the daisy chain can be estimated as described here.

$$I_{IP} \sim I_{IPM} + I_{TO} + I_{IPDC}$$

Where:

**$I_{IP}$**  is the input +24V DC power current through the male power connector of the module.

**$I_{IPM}$**  is the input +24V DC power current required by the module itself (with no test output load current).

**$I_{TO}$**  is the total test output load current for test outputs N (0...11).

**$I_{IPDC}$**  is the total input +24V DC power current through the female power connector of the module (input +24V DC power current for the modules that follow in the daisy chain).

**$I_{IPM}$**  can be approximated by dividing the number of watts for each type of 1732ES module by +24V DC as listed here:

- 1732ES-IB12XOB4, 1732ES-IB12XOBV2 = 4.2 W
- 1732ES-IB8XOB8, 1732ES-IB8XOBV4 = 3.96 W
- 1732ES-IB16 = 4.56 W

The table input +24V DC power calculation shows an example input +24V DC power current calculation for a system of four 1732ES-IB12XOB4 modules. The input +24V DC power voltage is 24V DC in this example. Module 1 is the first module in the daisy chain. Fill out the table by starting with the last module in the daisy chain, in this example Module 4. Once  **$I_{IP}$**  is calculated for module 4, it transfers as the  **$I_{IPDC}$**  value for Module 3. This process continues for all modules in the daisy chain.



As shown in the cell with value set in bold, the maximum input +24V DC power current through the male power connectors in the daisy chain is 6.5 A. This value is less than 10 A, so this system is adequate. The  $I_{IP}$  value for a module in this system or any daisy chained system cannot exceed 10 A. If the value exceeds 10 A, the system fails to meet the maximum current requirement for the module. The maximum current requirement is the maximum current that any pin on the power connectors can carry, which is 10 A.

**Table 14 - Input +24V DC Power Calculation**

Value	Module 1	Module 2	Module 3	Module 4
$I_{PDC}$	4.875 A	3.250 A	1.625 A	0.000 A
$I_{IPM}$	0.175 A	0.175 A	0.175 A	0.175 A
$I_{T00}$	0.005 A	0.005 A	0.005 A	0.700 A
$I_{T01}$	0.005 A	0.005 A	0.005 A	0.700 A
$I_{T02}$	0.005 A	0.005 A	0.700 A	0.005 A
$I_{T03}$	0.005 A	0.005 A	0.700 A	0.005 A
$I_{T04}$	0.005 A	0.700 A	0.005 A	0.005 A
$I_{T05}$	0.005 A	0.700 A	0.005 A	0.005 A
$I_{T06}$	0.700 A	0.005 A	0.005 A	0.005 A
$I_{T07}$	0.700 A	0.005 A	0.005 A	0.005 A
$I_{T08}$	0.005 A	0.005 A	0.005 A	0.005 A
$I_{T09}$	0.005 A	0.005 A	0.005 A	0.005 A
$I_{T010}$	0.005 A	0.005 A	0.005 A	0.005 A
$I_{T011}$	0.005 A	0.005 A	0.005 A	0.005 A
$I_{IP}$	<b>6.500 A</b>	4.875 A	3.250 A	1.625 A

The output +24V DC power current that is required for a module in the daisy chain can be estimated as described here.

$$I_{OP} \sim I_{OPM} + I_{SO} + I_{SNSO} + I_{OPDC}$$

Where:

$I_{OP}$  is the output +24V DC power current through the male power connector of the module.

$I_{OPM}$  is the output +24V DC power current required by the module itself (with no safety output load current).

$I_{SO}$  is the total safety output load current for safety outputs N. Modules with bipolar safety outputs enter values only in the even numbered  $I_{SO}$  table locations. Modules with sourcing-only safety outputs enter values in all ISO table locations.

$I_{SNSO}$  is the total sensor output load current for the Output +24V DC power output pins (pin 1 in the output I/O connectors).

$I_{OPDC}$  is the total output +24V DC power current through the female power connector of the module (output +24V DC power current for the modules that follow in the daisy chain).

$I_{OPM}$  can be approximated by dividing the number of watts for each type of 1732ES module by +24V DC as listed here:

- 1732ES-IB12XOBV2 - 1.56W
- 1732ES-IB12XOB4 - 1.08W
- 1732ES-IB8XOB8 - 1.56W
- 1732ES-IB8XOBV4 - 2.64 W

The table output +24V DC power calculation shows an example output +24V DC power current calculation for a system of four modules. The output +24V DC power voltage is 24V DC in this example. Module 1 is the first module in the daisy chain. Modules 1 and 3 are 1732ES-IB12XOBV2 modules and have bipolar safety outputs. Modules 2 and 4 are 1732ES-IB12XOB4 modules and have sourcing safety outputs. Fill out the table by starting with the last module in the daisy chain, in this example Module 4. Once  $I_{OP}$  is calculated for module 4, it transfers as the  $I_{OPDC}$  value for Module 3. This process continues for all modules in the daisy chain.

As can be seen in the cell with value set in bold, the maximum output +24V DC power current through the male power connectors in the daisy chain is 9.02 A. This value is less than 10 A, so this system is adequate. The  $I_{OP}$  value for a module in this system or any daisy chained system cannot exceed 10 A. If the value exceeds 10 A, the system fails to meet the maximum current requirement for the module. The maximum current requirement is the maximum current that any pin on the power connectors can carry, which is 10 A.

**Table 15 - Output +24V DC Power Calculation**

Value	Module 1	Module 2	Module 3	Module 4
$I_{opdc}$	6.755 A	4.600 A	2.245 A	0.000 A
$I_{opm}$	0.065 A	0.045 A	0.065 A	0.045 A
$I_{so0}$	1.000 A	0.500 A	1.000 A	0.500 A
$I_{so1}$	–	0.500 A	–	0.500 A
$I_{so2}$	1.000 A	0.500 A	1.000 A	0.500 A
$I_{so3}$	–	0.500 A	–	0.500 A
$I_{so4}$	–	–	–	–
$I_{so5}$	–	–	–	–
$I_{so6}$	–	–	–	–
$I_{so7}$	–	–	–	–
$I_{SNSO}$	0.200 A	0.200 A	0.200 A	0.200 A
$I_{op}$	<b>9.020 A</b>	6.755 A	4.600 A	2.245 A



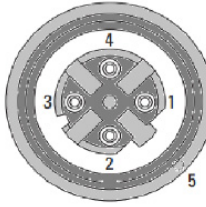
**ATTENTION:** To comply with the CE Low Voltage Directive (LVD), this equipment and all connected I/O must be powered from a source compliant with Safety Extra Low Voltage (SELV) or Protected Extra Low Voltage (PELV).

## EtherNet/IP Connections

This section describes the EtherNet/IP connector and sample cables.

**Table 16 - EtherNet/IP Connector Pin Description**

Pin No.	Signal
1	Tx+
2	Rx+
3	Tx-
4	Rx-
5	Shell/Shield



**Table 17 - Sample EtherNet/IP Cables**

Description	Cat. No.
M12 D-Coded straight to RJ45 patchcord	1585D-M4UBJM-2 <sup>(1)</sup>
M12 D-Coded straight to flying leads cordset	1585D-M4UB-2 <sup>(1)</sup>
M12 D-Coded straight to M12 straight patchcord	1585D-M4UBDM-2 <sup>(1)</sup>
M12 D-Coded right angle to M12 right angle patchcord	1585D-E4UBDE-2 <sup>(1)</sup>

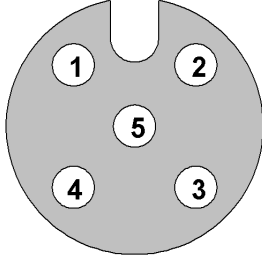
(1) Replace -2 (2 m [6.6 ft]) with -1 (1 m [3.3 ft]), -5 (5 m [16.4 ft]) or -10 (10 m [32.8 ft]) for additional standard cable lengths.

See <http://www.ab.com/en/epub/catalogs/6005557/6005561/10514505/10515166/Introduction.html> for additional information.

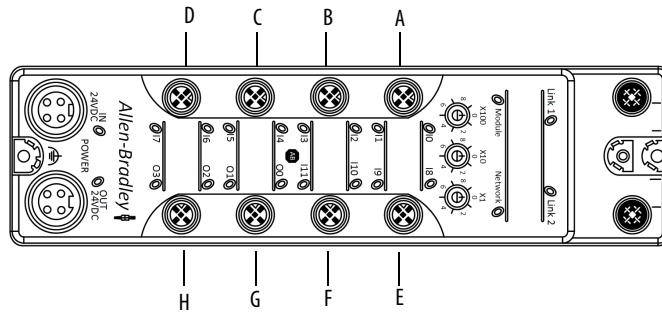
## I/O Connections

This section describes the I/O connectors and recommended cables.

**Table 18 - I/O Connector Pin Description**

Pin No.	Input Signal	I/O Connector	Bipolar Output Signal	Sourcing Output Signal
1	Test out n+1		Output +24V DC power	Output +24V DC power
2	Input n+1		Output n+1 (N) (sinking)	Output n+1
3	Input common		Output power common	Output power common
4	Input n		Output n (P) (sourcing)	Output n
5	Test out n		Output power common	Output power common
Case	No connect	No connect	No connect	No connect

**Figure 22 - I/O Connector Positions**



**Table 19 - Terminal Positions**

Terminal	1732ES-IB12X0BV2	1732ES-IB12X0B4	1732ES-IB16	1732ES-IB8X0BV4	1732ES-IB8X0B8
A-1	Test out 1	Test out 1	Test out 1	Test out 1	Test out 1
A-2	Safety input 1	Safety input 1	Safety input 1	Safety input 1	Safety input 1
A-3	Input common	Input common	Input common	Input common	Input common
A-4	Safety input 0	Safety input 0	Safety input 0	Safety input 0	Safety input 0
A-5	Test out 0	Test out 0	Test out 0	Test out 0	Test out 0
B-1	Test out 3	Test out 3	Test out 3	Test out 3	Test out 3
B-2	Safety input 3	Safety input 3	Safety input 3	Safety input 3	Safety input 3
B-3	Input common	Input common	Input common	Input common	Input common
B-4	Safety input 2	Safety input 2	Safety input 2	Safety input 2	Safety input 2
B-5	Test out 2	Test out 2	Test out 2	Test out 2	Test out 2
C-1	Test out 5	Test out 5	Test out 5	Test out 5	Test out 5
C-2	Safety input 5	Safety input 5	Safety input 5	Safety input 5	Safety input 5
C-3	Input common	Input common	Input common	Input common	Input common
C-4	Safety input 4	Safety input 4	Safety input 4	Safety input 4	Safety input 4

Table 19 - Terminal Positions (Continued)

Terminal	1732ES-IB12XOBV2	1732ES-IB12XOB4	1732ES-IB16	1732ES-IB8XOBV4	1732ES-IB8XOB8
C-5	Test out 4	Test out 4	Test out 4	Test out 4	Test out 4
D-1	Test out 7	Test out 7	Test out 7	Test out 7	Test out 7
D-2	Safety input 7	Safety input 7	Safety input 7	Safety input 7	Safety input 7
D-3	Input common	Input common	Input common	Input common	Input common
D-4	Safety input 6	Safety input 6	Safety input 6	Safety input 6	Safety input 6
D-5	Test out 6	Test out 6	Test out 6	Test out 6	Test out 6
E-1	Test out 9	Test out 9	Test out 9	Output +24V DC power	Output +24V DC power
E-2	Safety input 9	Safety input 9	Safety input 9	Safety output 1 <sup>(1)</sup> (N) (sinking)	Safety output 1 <sup>(3)</sup> (sourcing)
E-3	Input common	Input common	Input common	Output power common	Output power common
E-4	Safety input 8	Safety input 8	Safety input 8	Safety output 0 <sup>(1)</sup> (P) (sourcing)	Safety output 0 <sup>(3)</sup> (sourcing)
E-5	Test out 8	Test out 8	Test out 8	Output power common	Output power common
F-1	Test out 11	Test out 11	Test out 11	Output +24V DC power	Output +24V DC power
F-2	Safety input 11	Safety input 11	Safety input 11	Safety output 3 <sup>(2)</sup> (N) (sinking)	Safety output 3 <sup>(4)</sup> (sourcing)
F-3	Input common	Input common	Input common	Output power common	Output power common
F-4	Safety input 10	Safety input 10	Safety input 10	Safety output 2 <sup>(2)</sup> (P) (sourcing)	Safety output 2 <sup>(4)</sup> (sourcing)
F-5	Test out 10	Test out 10	Test out 10	Output power common	Output power common
G-1	Output +24V DC power	Output +24V DC power	Test out 13	Output +24V DC power	Output +24V DC power
G-2	Safety output 1 <sup>(1)</sup> (N) (sinking)	Safety output 1 <sup>(3)</sup> (sourcing)	Safety input 13	Safety output 5 <sup>(5)</sup> (N) (sinking)	Safety output 5 <sup>(7)</sup> (sourcing)
G-3	Output power common	Output power common	Input common	Output power common	Output power common
G-4	Safety output 0 <sup>(1)</sup> (P) (sourcing)	Safety output 0 <sup>(3)</sup> (sourcing)	Safety input 12	Safety output 4 <sup>(5)</sup> (P) (sourcing)	Safety output 4 <sup>(7)</sup> (sourcing)
G-5	Output power common	Output power common	Test out 12	Output power common	Output power common
H-1	Output +24V DC power	Output +24V DC power	Test out 15	Output +24V DC power	Output +24V DC power
H-2	Safety output 3 <sup>(2)</sup> (N) (sinking)	Safety output 3 <sup>(4)</sup> (sourcing)	Safety input 15	Safety output 7 <sup>(6)</sup> (N) (sinking)	Safety output 7 <sup>(8)</sup> (sourcing)
H-3	Output power common	Output power common	Input common	Output power common	Output power common
H-4	Safety output 2 <sup>(2)</sup> (P) (sourcing)	Safety output 2 <sup>(4)</sup> (sourcing)	Safety input 14	Safety output 6 <sup>(6)</sup> (P) (sourcing)	Safety output 6 <sup>(8)</sup> (sourcing)
H-5	Output power common	Output power common	Test out 14	Output power common	Output power common

(1) Safety outputs 0/1 must be controlled as a pair.

(2) Safety outputs 2/3 must be controlled as a pair.

(3) Safety outputs 0/1 may be controlled individually or as a pair.

(4) Safety outputs 2/3 may be controlled individually or as a pair.

(5) Safety outputs 4/5 must be controlled as a pair.

(6) Safety outputs 6/7 must be controlled as a pair.

(7) Safety outputs 4/5 may be controlled individually or as a pair.

(8) Safety outputs 6/7 may be controlled individually or as a pair.

**Table 20 - Recommended I/O Connector Cables**

Description	Cat. No.
M12 right-angle male to flying leads cordset	889D-E5AC-2 <sup>(1)</sup>
M12 straight-male to flying leads cordset	889D-M5AC-2 <sup>(1)</sup>
M12 right-angle male to straight female patchcord	889D-F5ACDE-2 <sup>(2)</sup>
M12 straight male to straight female patchcord	889D-F5ACDM-2 <sup>(2)</sup>

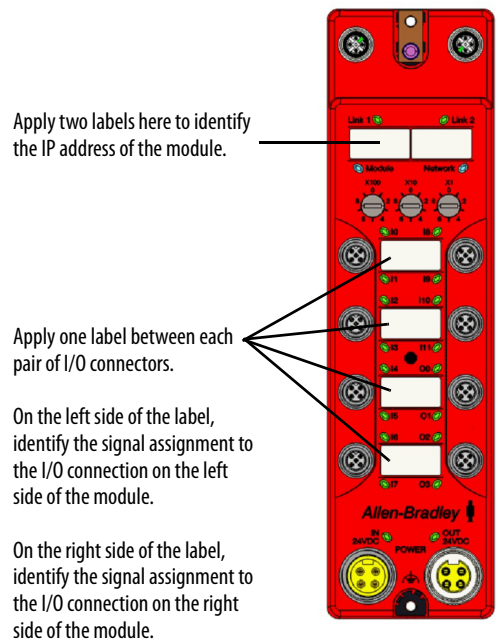
- (1) Replace -2 (2 m [6.6 ft]) with -5 (5 m [16.4 ft]) or -10 (10 m [32.8 ft]) for additional standard cable lengths.
- (2) Replace -2 (2m [6.6 ft]) with -0M3 (0.3 m [1.0 ft]), -1 (1 m [3.3 ft]), -5 (5 m [16.4 ft]), or -10 (10 m [32.8 ft]) for additional standard cable lengths.

See <http://www.ab.com/en/epub/catalogs/6005557/6005561/6125318/8613745/8613769/8613771/Introduction.html> for additional information.

### Label the IP Address and Device Connections

The 1732ES module ships with 12 white labels that you can use to identify the IP address of the module, and the input and output connections. There are six areas on the module to place the labels, with six additional labels that can be used if the IP address or device connections change.

Use a pen or indelible marker with a fine tip to write on the labels. You can also use a printing device to print the data onto the label. Contact a Brady representative at <http://www.bradyid.com> and ask about printer compatibility for part number PTLEP-171-593.



**IMPORTANT:** Be sure that the surface of the module is clean and dry before you apply the labels to the module.

## Wiring Examples

Topic	Page
Wiring Examples for Safety Categories	64
Wiring by Application	67

For more examples, see the Safety Functions available at [http://marketing.rockwellautomation.com/safety/en/safety\\_functions](http://marketing.rockwellautomation.com/safety/en/safety_functions).

You can also go to Literature Library at <http://www.rockwellautomation.com/global/literature-library/overview.page> and enter SAFETY-AT in the search field.

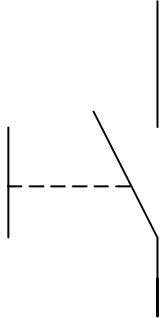
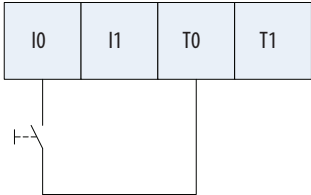
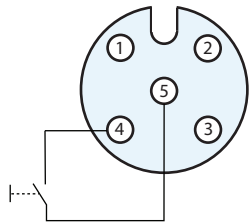
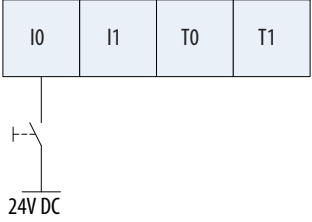
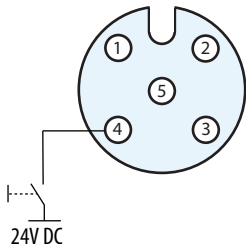
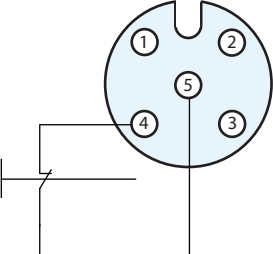
These publications provide guidance for a specific safety function based on the following:

- Functional requirements
- Equipment selection
- Performance level requirements
- Setup and wiring
- Configuration
- Verification and validation plans
- Calculation of performance level

# Wiring Examples for Safety Categories

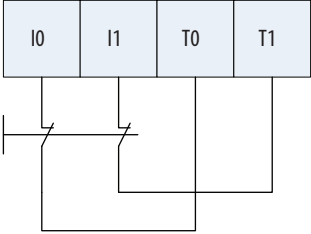
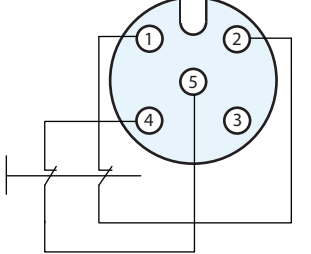
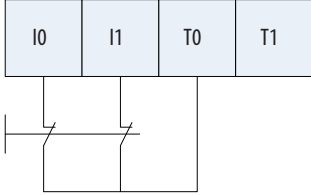
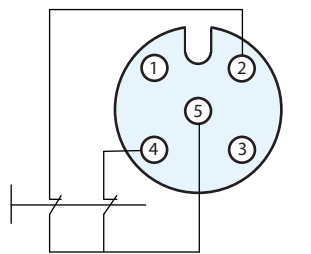
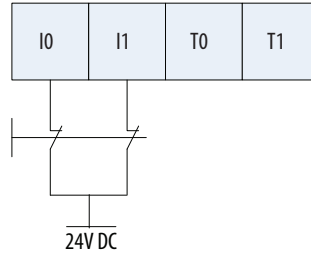
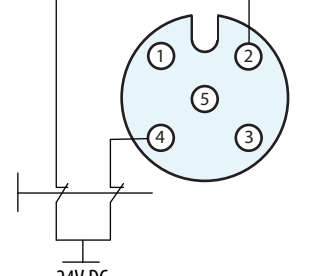
Read this chapter for information about wiring and safety categories. See [Table 21](#) for more information on input device connection methods and their safety categories.

**Table 21 - Input Device Connection Methods and Safety Categories**

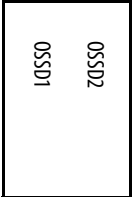
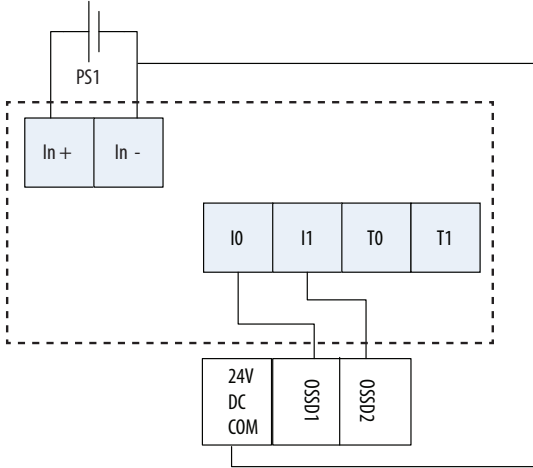
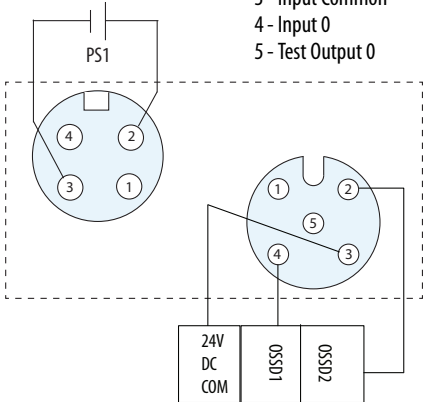
Connected Device	Test Pulse from Test Output	Connection	Schematic Diagram	Safety Category	Maximum Performance Level
	No	Connect the switch between I0 and T0. T0 must be configured as 24V power supply.	<p>1791ES Modules</p>  <p>1732ES Modules</p> <p>1 - Test Output 1 2 - Input 1 3 - Input Common 4 - Input 0 5 - Test Output 0</p> 	-	C
		Connect the switch between 24V DC and I0.	<p>1791ES Modules</p>  <p>1732ES Modules</p> <p>1 - Test Output 1 2 - Input 1 3 - Input Common 4 - Input 0 5 - Test Output 0</p> 	-	C
Single-channel safety device	Yes	Connect the switch between I0 and T0	<p>Only 1732ES Modules</p> <p>1 - Test Output 1 2 - Input 1 3 - Input Common 4 - Input 0 5 - Test Output 0</p> 	2	D



**Table 21 - Input Device Connection Methods and Safety Categories (Continued)**

Connected Device	Test Pulse from Test Output	Connection	Schematic Diagram	Safety Category	Maximum Performance Level
Emergency stop switch Door monitor	Yes	Connect the switches between I0 and T0, and I1 and T1	<p>1791ES Modules</p>  <p>1732ES Modules</p> <ul style="list-style-type: none"> <li>1 - Test Output 1</li> <li>2 - Input 1</li> <li>3 - Input Common</li> <li>4 - Input 0</li> <li>5 - Test Output 0</li> </ul> 	4	E
Emergency stop switch Door monitor	No	Connect the switches between T0 and I0 and I1. T0 is configured for 24V power supply.	<p>1791ES Modules</p>  <p>1732ES Modules</p> <ul style="list-style-type: none"> <li>1 - Test Output 1</li> <li>2 - Input 1</li> <li>3 - Input Common</li> <li>4 - Input 0</li> <li>5 - Test Output 0</li> </ul> 	3	D
		Connect the switches between 24V DC and I0 and I1.	<p>1791ES Modules</p>  <p>1732ES Modules</p> <ul style="list-style-type: none"> <li>1 - Test Output 1</li> <li>2 - Input 1</li> <li>3 - Input Common</li> <li>4 - Input 0</li> <li>5 - Test Output 0</li> </ul> 		D

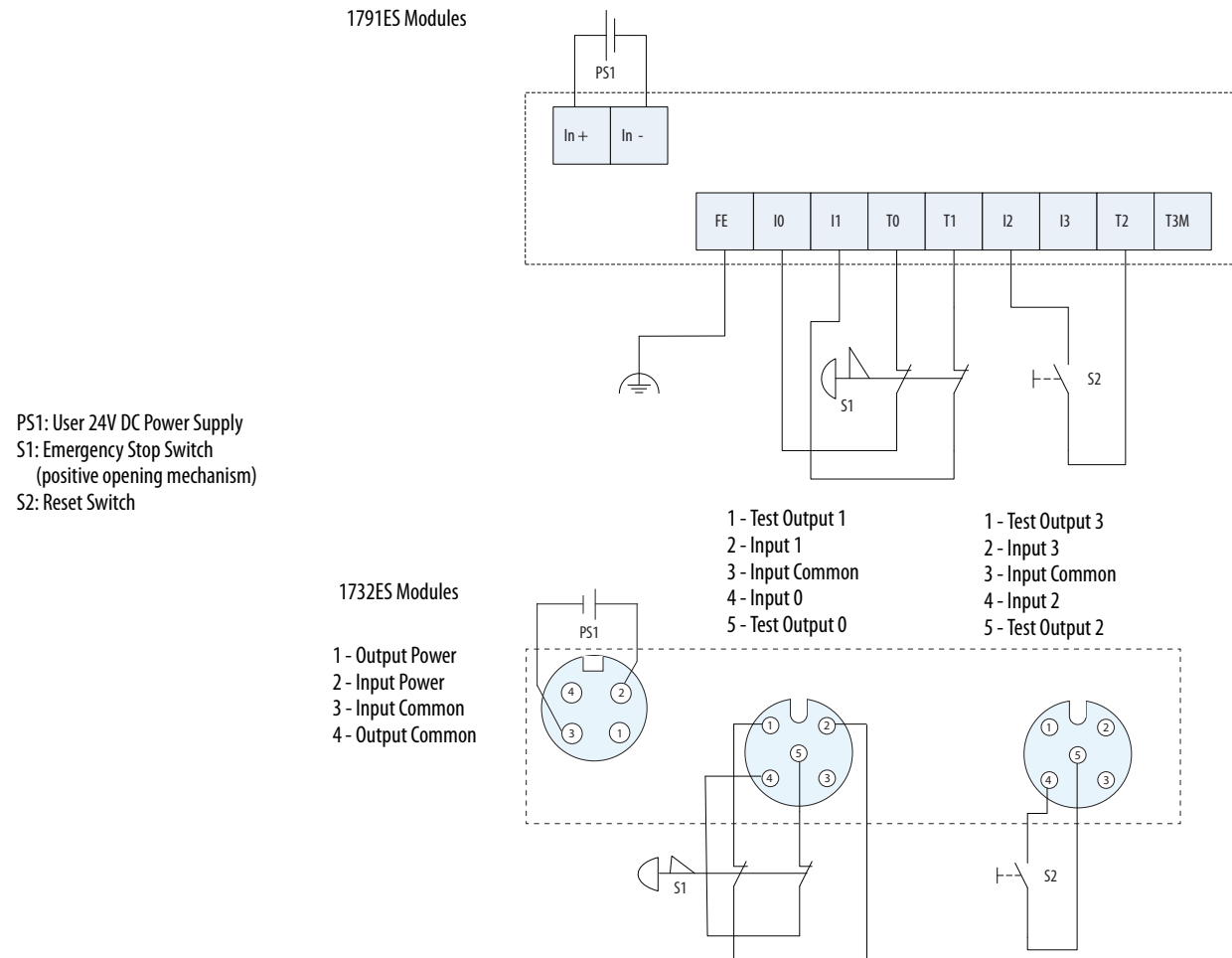
**Table 21 - Input Device Connection Methods and Safety Categories (Continued)**

Connected Device	Test Pulse from Test Output	Connection	Schematic Diagram	Safety Category	Maximum Performance Level
<p>Light curtain</p> 	<p>Yes</p>	<p>Connect the OSSD1 and OSSD2 to I0 and I1, respectively. Connect the 24V power supply commons.</p>	<p>1791ES Modules</p>  <p>1732ES Modules</p>  <p>1 - Output Power 2 - Input Power 3 - Input Common 4 - Output Common</p> <p>1 - Test Output 1 2 - Input 1 3 - Input Common 4 - Input 0 5 - Test Output 0</p>	<p>3 or 4 based on light curtain being used</p>	<p>E</p>

## Wiring by Application

Read this section for examples of wiring by application. See catalog number details for appropriate module.

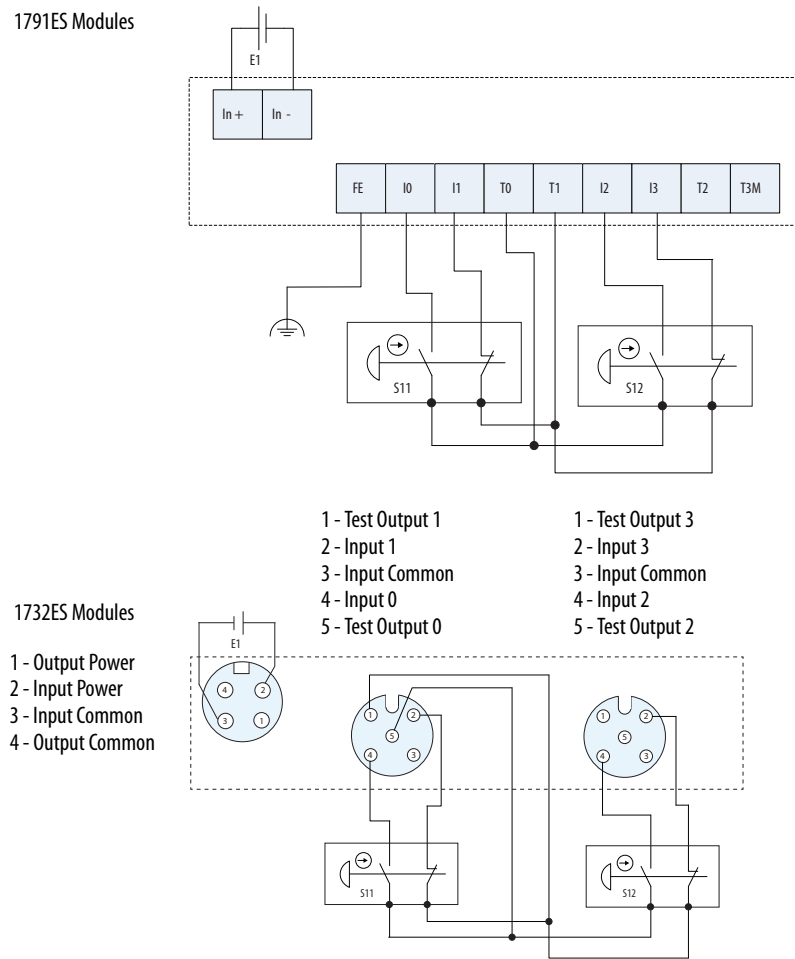
**Figure 23 - Emergency Stop Switch Dual-channel Inputs with Manual Reset**



Controller Configuration	Parameter Name	Configuration Setting
Safety Input 0	Safety Input 0 Channel Mode	Test Pulse from Test Output
	Safety Input 0 Test Source	Test Output 0
	Dual-channel Safety Input 0/1 Mode	Dual-channel Equivalent
	Dual-channel Safety Input 0/1 Discrepancy Time	100 ms (application dependent)
Safety Input 1	Safety Input 1 Channel Mode	Test Pulse from Test Output
	Safety Input 1 Test Source	Test Output 1
Safety Input 2	Safety Input 2 Channel Mode	Used as standard input
	Safety Input 2 Test Source	Not Used
	Dual-channel Safety Input 2/3 Mode	Single Channel
Test Output 0	Test Output 0 Mode	Pulse Test Output
Test Output 1	Test Output 1 Mode	Pulse Test Output
Test Output 2	Test Output 2 Mode	Power Supply Output

This example shows wiring and controller configuration when using the Guard I/O module. If used in combination with the programs in a safety controller, this wiring is Safety Category 4 in accordance with ISO 13849-1:2008 wiring requirements.

Figure 24 - Two-hand Monitor

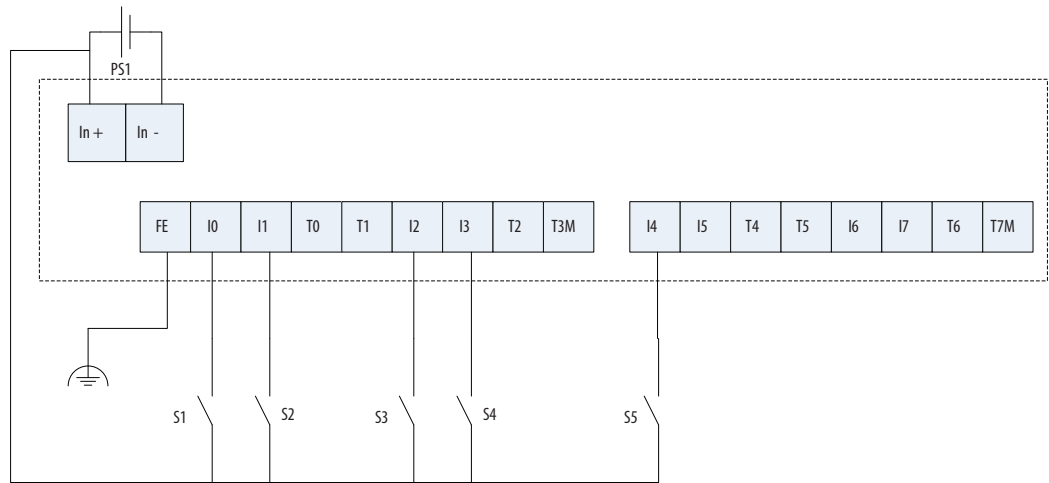


Controller Configuration	Parameter Name	Configuration Setting
Safety Input 0	Safety Input 0 Channel Mode	Test Pulse from Test Output
	Safety Input 0 Test Source	Test Output 0
	Dual Channel Safety Input 0/1 Mode	Dual Channel Complementary
	Dual Channel Safety Input 0/1 Discrepancy Time	100 ms (application dependent)
Safety Input 1	Safety Input 1 Channel Mode	Test Pulse from Test Output
	Safety Input 1 Test Source	Test Output 1
Safety Input 2	Safety Input 2 Channel Mode	Test Pulse from Test Output
	Safety Input 2 Test Source	Test Output 0
	Dual Channel Safety Input 2/3 Mode	Dual Channel Complementary
	Dual Channel Safety Input 2/3 Discrepancy Time	100 ms (application dependent)
Safety Input 3	Safety Input 3 Channel Mode	Test Pulse from Test Output
	Safety Input 3 Test Source	Test Output 1
Test Output 0	Test Output 0 Mode	Pulse Test Output
Test Output 1	Test Output 1 Mode	Pulse Test Output

This example shows wiring and controller configuration when using the Guard I/O™ module. If used in combination with the programs of a safety controller, the wiring is Category 4 in accordance with ISO 13849-1:2008 wiring requirements.

Figure 25 - Mode Select Switch

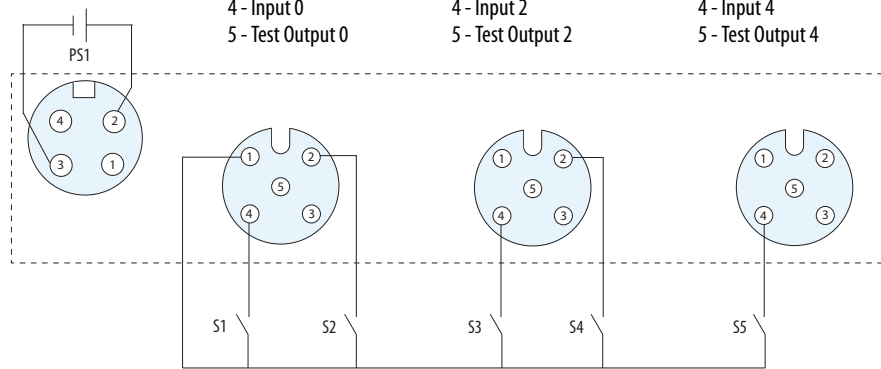
1791ES Modules



PS1: User 24V DC Power Supply  
S1...S5: Switches

1732ES Modules

1 - Output Power  
2 - Input Power  
3 - Input Common  
4 - Output Common



1 - Test Output 1  
2 - Input 1  
3 - Input Common  
4 - Input 0  
5 - Test Output 0

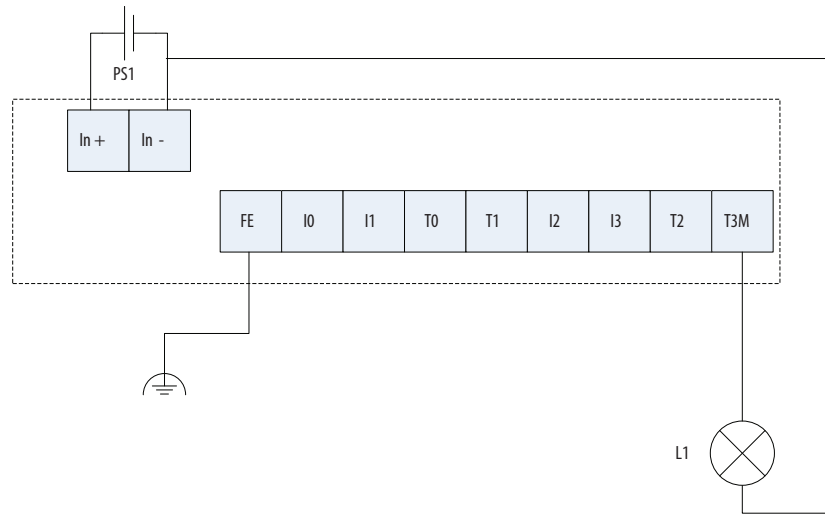
1 - Test Output 3  
2 - Input 3  
3 - Input Common  
4 - Input 2  
5 - Test Output 2

1 - Test Output 5  
2 - Input 5  
3 - Input Common  
4 - Input 4  
5 - Test Output 4

Controller Configuration	Parameter Name	Configuration Setting
Safety Input 0	Safety Input 0 Channel Mode	Safety Input
	Safety Input 0 Test Source	None
	Dual Channel Safety Input 0/1 Mode	Single Channel
Safety Input 1	Safety Input 1 Channel Mode	Safety Input
	Safety Input 1 Test Source	None
	Dual Channel Safety Input 2/3 Mode	Single Channel
Safety Input 2	Safety Input 2 Channel Mode	Safety Input
	Safety Input 2 Test Source	None
	Dual Channel Safety Input 2/3 Mode	Single Channel
Safety Input 3	Safety Input 3 Channel Mode	Safety Input
	Safety Input 3 Test Source	None
	Dual Channel Safety Input 4/5 Mode	Single Channel
Safety Input 4	Safety Input 4 Channel Mode	Safety Input
	Safety Input 4 Test Source	None
	Dual Channel Safety Input 4/5 Mode	Single Channel
Test Output 0	Test Output 0 Mode	Power Supply

Figure 26 - Muting Lamp Output

1791ES Modules



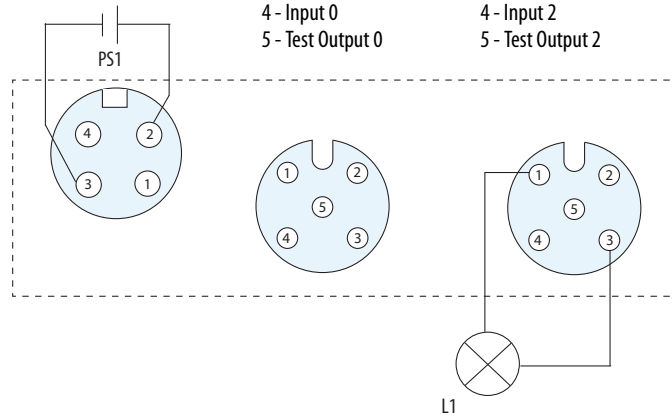
PS1: User 24V DC Power Supply  
L1: External Muting Lamp

1732ES Modules

1 - Output Power  
2 - Input Power  
3 - Input Common  
4 - Output Common

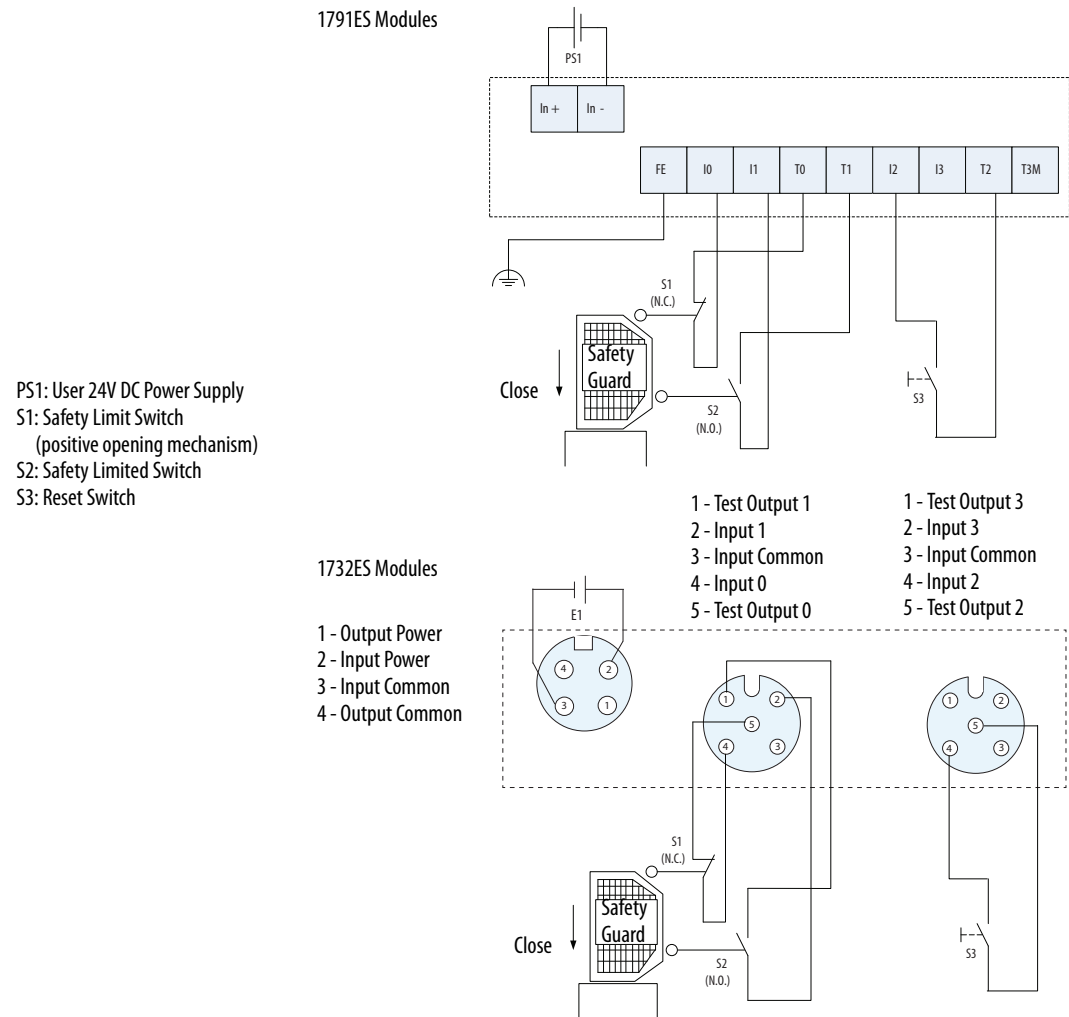
1 - Test Output 1  
2 - Input 1  
3 - Input Common  
4 - Input 0  
5 - Test Output 0

1 - Test Output 3  
2 - Input 3  
3 - Input Common  
4 - Input 2  
5 - Test Output 2



Controller Configuration	Parameter Name	Configuration Setting
Test Output 3	Test Output 3 Mode	Muting Lamp Output

**Figure 27 - Limit Switch Dual-channel Inputs and a Manual Reset**

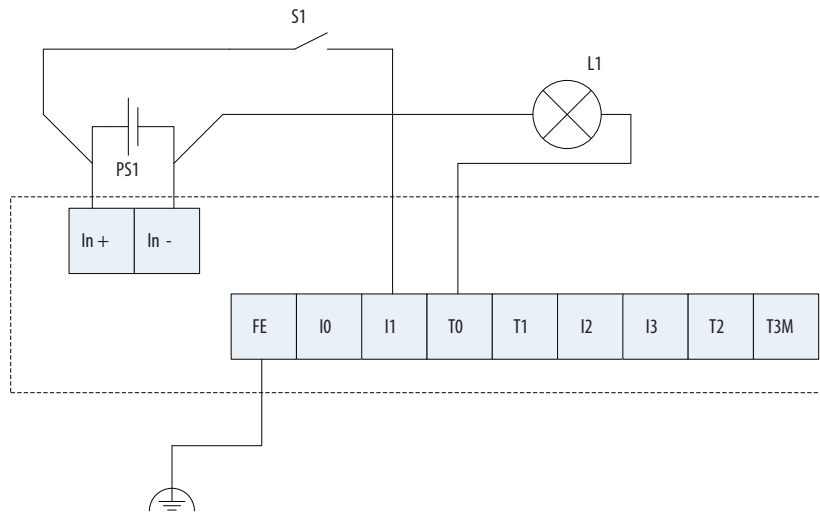


Controller Configuration	Parameter Name	Configuration Setting
Safety Input 0	Safety Input 0 Channel Mode	Test Pulse from Test Output
	Safety Input 0 Test Source	Test Output 0
	Dual-channel Safety Input 0/1 Mode	Dual-channel Equivalent
	Dual-channel Safety Input 0/1 Discrepancy Time	1000 ms (application dependent)
Safety Input 1	Safety Input 1 Channel Mode	Test Pulse from Test Output
	Safety Input 1 Test Source	Test Output 1
Safety Input 2	Safety Input 2 Channel Mode	Used as Standard Input
	Safety Input 2 Test Source	Not Used
	Dual-channel Safety Input 2/3 Mode	Single Channel
Test Output 0	Test Output 0 Mode	Pulse Test Output
Test Output 1	Test Output 1 Mode	Pulse Test Output
Test Output 2	Test Output 2 Mode	Power Supply Output

This example shows wiring and controller configuration when using the Guard I/O module with limit switch dual-channel inputs and a manual reset. If used in combination with the programs of a safety controller, the wiring is Category 4 in accordance with ISO 13849-1:2008 wiring requirements.

Figure 28 - Guard I/O Module with Limit Switch Dual-channel Inputs and a Manual Reset

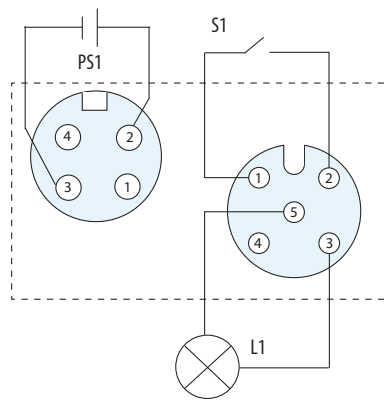
1791ES Modules



PS1: User 24V DC Power Supply  
 L1: Lamp  
 S1: Switch

1732ES Modules

1 - Output Power  
 2 - Input Power  
 3 - Input Common  
 4 - Output Common



1 - Test Output 1  
 2 - Input 1  
 3 - Input Common  
 4 - Input 0  
 5 - Test Output 0

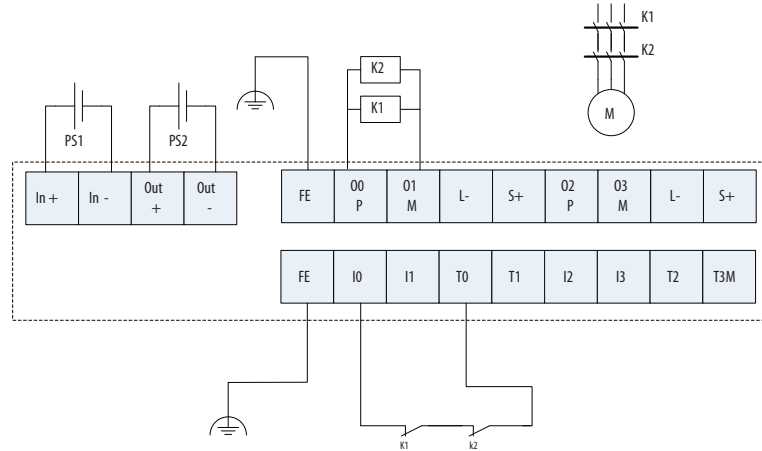
Controller Configuration	Parameter Name	Configuration Setting
Safety Input 1	Safety Input 1 Channel Mode	Standard Input
	Safety Input 1 Test Source	None
	Dual-channel Safety Input 0/1 Mode	Single Channel
Test Output 0	Test Output 0 Mode	Standard Output
Test Output 1	Test Output 1 Mode	Power Supply



**IMPORTANT** For the bipolar safety outputs to work as intended, you **must** connect the devices that are being controlled as shown in this figure. Connection of devices directly to 24V DC, 0V DC, or ground is strictly prohibited.

**Figure 29 - Dual-load Bipolar Outputs (1732ES-IB12X0BV2 or 1732ES-IB8X0BV4)**

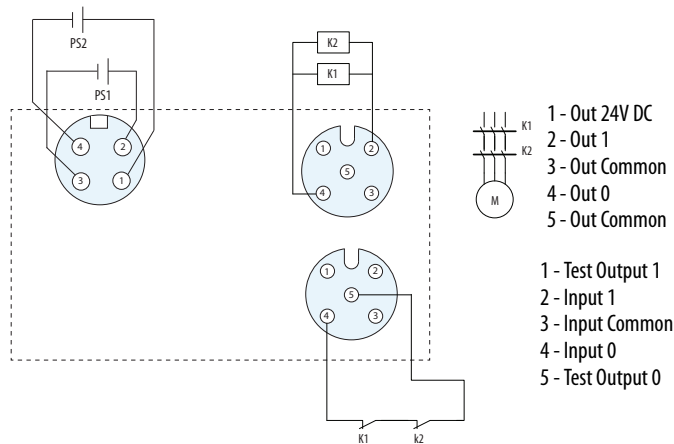
1791ES Modules



PS1, PS2: User 24V DC Power Supply  
(One power supply can be used for both input and output power.)

1732ES-IB12X0BV2 Module

- 1 - Output Power
- 2 - Input Power
- 3 - Input Common
- 4 - Output Common



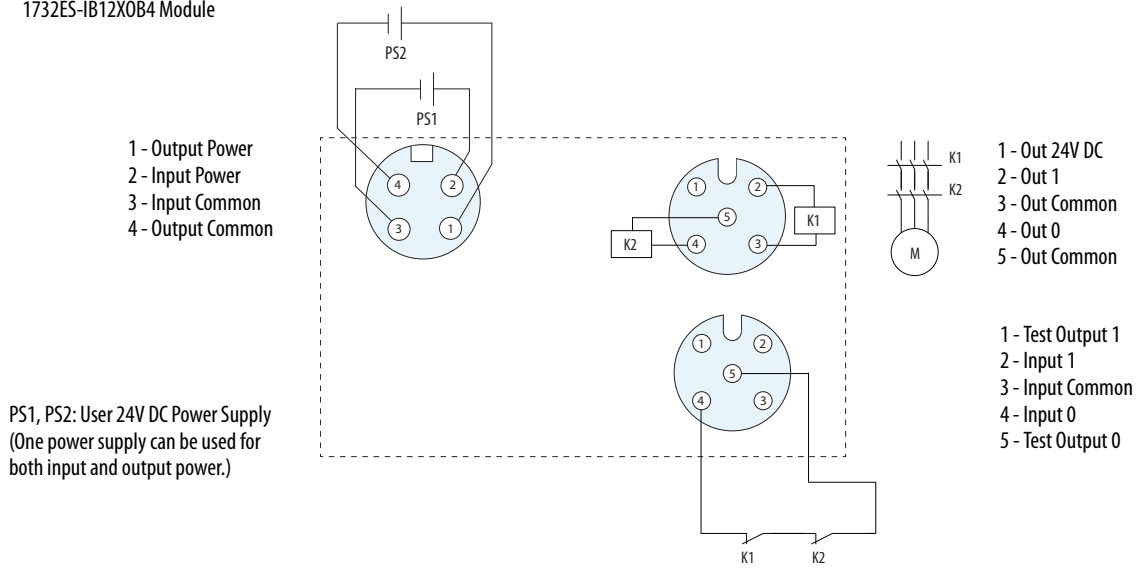
Controller Configuration	Parameter Name	Configuration Setting
Safety Input 0	Safety Input 0 Channel Mode	Test Pulse from Test Output
	Safety Input 0 Test Source	Test Output 0
	Dual-channel Safety Input 0/1 Mode	Single Channel
Test Output 0	Test Output 0 Mode	Pulse Test Output
Safety Output 0	Safety Output 0 Channel Mode	Safety Pulse Test
Safety Output 1	Safety Output 1 Channel Mode	Safety Pulse Test

This example shows wiring and configuration when using the Guard I/O module with solid-state outputs in Dual-channel mode.

All safety outputs of this Guard I/O module are permanently configured for use as Dual-channel mode only. When used in combination with the programs of the safety controller, this circuit configuration is Safety Category 4 in accordance with ISO 13849-1:2008 wiring requirements and is rated up to Performance Level e.

Figure 30 - Dual-load Sourcing Outputs – 1732ES-IB12XOB4 and 1732ES-IB8XOB8 Modules

1732ES-IB12XOB4 Module



Controller Configuration	Parameter Name	Configuration Setting
Safety Input 0	Safety Input 0 Channel Mode	Test Pulse from Test Output
	Safety Input 0 Test Source	Test Output 0
	Dual-channel Safety Input 0/1 Mode	Single Channel
Test Output 0	Test Output 0 Mode	Pulse Test Output
Safety Output 0/1	Safety Output 0/1 Operation Type	Dual
Safety Output 0	Safety Output 0 Channel Mode	Safety Pulse Test
Safety Output 1	Safety Output 1 Channel Mode	Safety Pulse Test

The example shows wiring and configuration when using the 1732ES-IB12XOB4 Guard I/O module with solid-state outputs in Dual-channel mode.

When used in combination with the programs of the safety controller, this circuit configuration is Safety Category 4 in accordance with ISO 13849-1:2008 wiring requirements and is rated up to Performance Level e.

## Configure the I/O Modules

Topic	Page
Add Modules to the I/O Configuration Tree	77
Configure the Module Properties	79
Configure the Safety Connections	86
Configure the Module Inputs	88
Configure the Test Outputs	90
Configure the Module Outputs	91
Save and Download the Module Configuration	92

Use the Studio 5000 Logix Designer® application to configure the modules.

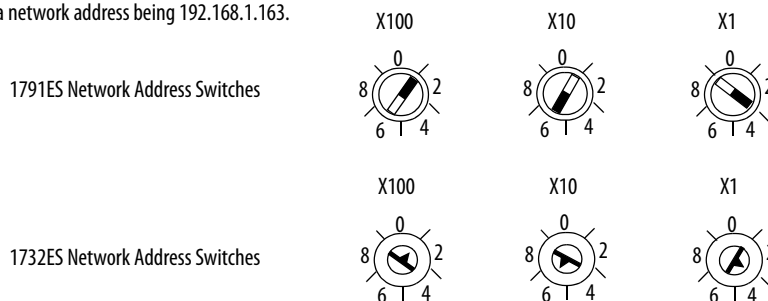
At the bottom of a dialog box, choose Help for information about how to complete entries in the dialog box. At the bottom of a warning dialog box, choose Help to get information about that specific error.

### Set the IP Address

If the network uses 192.168.1.x, use the rotary switches on the module to set the last octet of network IP address. Valid numbers range from 001...254.

**Figure 31 - Example Network Address**

This example shows the switches set at 163 with a network address being 192.168.1.163.



**WARNING:** When you change switch settings while power is on, an electrical arc can occur. This could cause an explosion in hazardous location installations. Be sure that power is removed or the area is nonhazardous before proceeding.



---

**ATTENTION:** Set a suitable network IP addresses before connecting the module to a network.

---

---

**IMPORTANT** 1732ES modules have plastic dust caps that cover the network IP switches. Remove the dust caps to adjust the IP address switches.

The dust caps must be installed to maintain the ingress protection (IPxx) rating marked on the 1732ES modules.

Torque the dust caps to  $0.3 \pm 0.03 \text{ N}\cdot\text{m}$  ( $2.5 \pm 0.3 \text{ lb}\cdot\text{in}$ ).

---

If DHCP is not enabled, the module uses the IP address (along with other TCP configurable parameters) stored in nonvolatile memory.

---

**IMPORTANT** Your module comes preconfigured with a gateway address of 192.168.1.1.

---

At power-up, the module reads the rotary switches to determine if they are set to a valid number for the last octet of the IP address. If the settings are a valid number, these conditions result:

- IP address = 192.168.1.xxx (where xxx represents the switch settings)
- Subnet mask = 255.255.255.0
- Gateway address = 192.168.1.1
- The module does not have an assigned host name, nor does it use any Domain Name System.

---

**IMPORTANT** The gateway address automatically changes to 0.0.0.0 if the address switches are set to match the gateway address.

---

If the network does not use 192.168.1.x, after you install and power up the module, you can use the following tools to set the network IP address:

- Bootstrap Protocol/Dynamic Host Configuration Protocol (BOOTP/DHCP) server
- RSLinx® Classic software
- Studio 5000 Logix Designer application

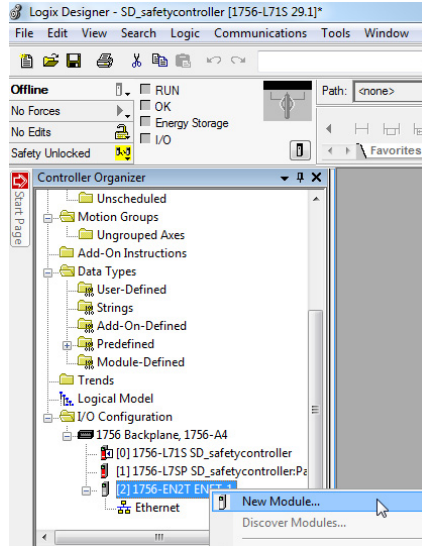
Apply two labels to the module to identify the IP address of the module.

For more information on how to configure the module with these tools, see the EtherNet/IP Communication Modules in 5000 Series Systems User Manual, publication [ENET-UM004](#).

## Add Modules to the I/O Configuration Tree

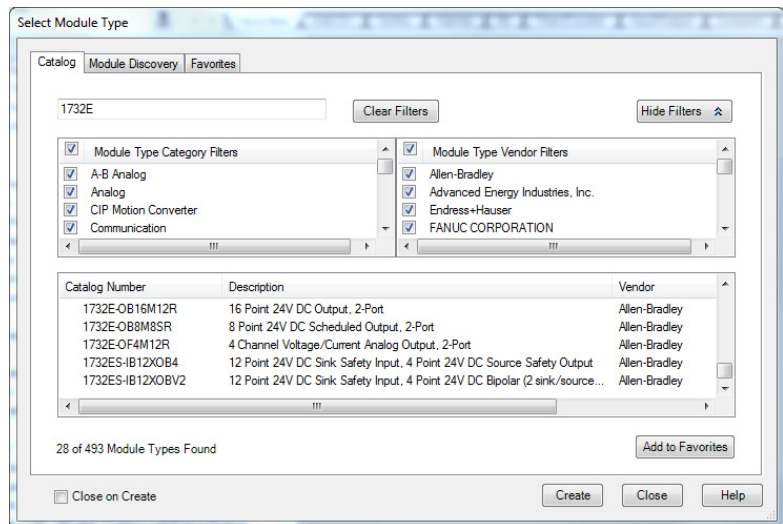
To add a module to the I/O configuration tree in your programming software project, follow these guidelines.

1. From the I/O Configuration tree, right-click the Ethernet bridge, as shown in the figure, and choose New Module.



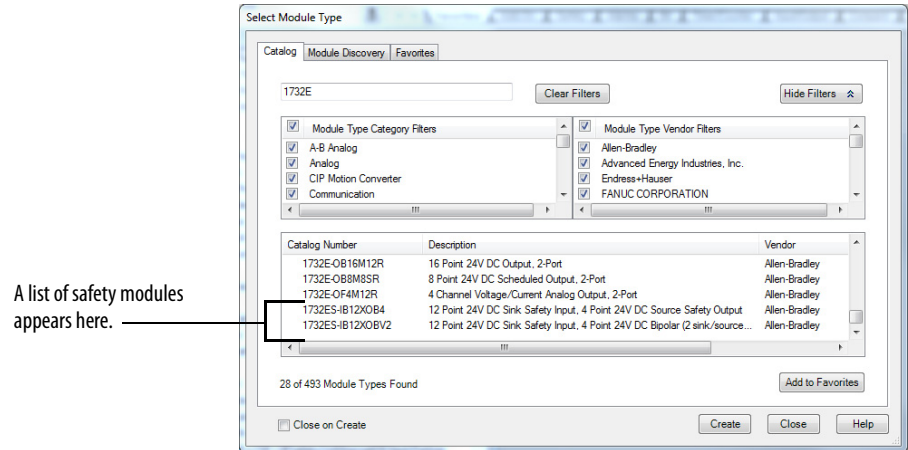
2. Uncheck the Module Type Category Filters box.
3. Scroll down through the list and check Safety.

The Select Module dialog box displays a list of safety modules and controllers.



4. Select the required safety module from the list.

This example uses the 1732ESIB12XOB4 module.

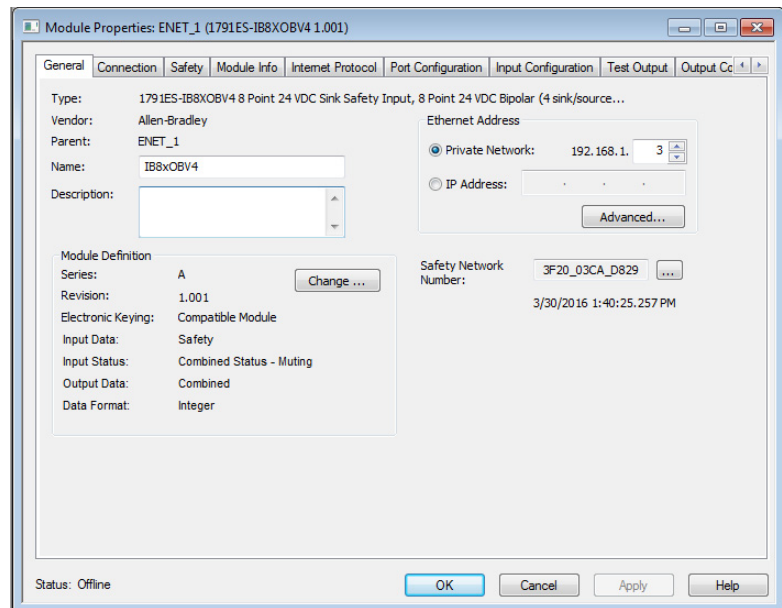


5. To add the module to your configuration, click Create.

## Configure the Module Properties

Follow these steps to configure the general properties of the module.

1. From the I/O configuration tree, double-click the module, such as the 1791ES-IB8XOBV4 module, to see the Module Properties dialog box.



2. Type a unique name for the module.
3. If desired, type a description.

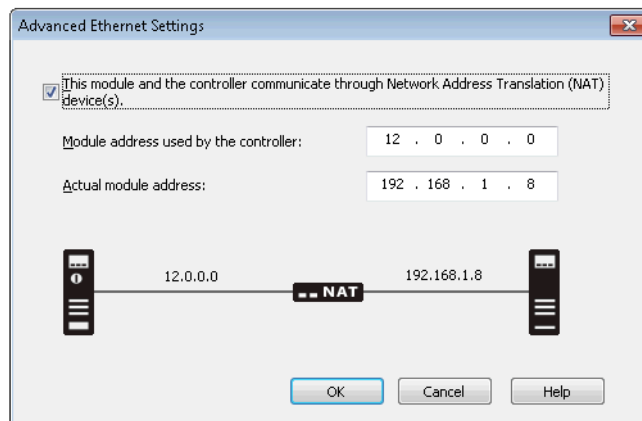
Note the safety network number (SNN). In most cases, you can use the default that is provided by the programming software. For a detailed explanation of the safety network number (SNN), see the GuardLogix® Controller Systems Safety Reference Manual that is listed in the [Additional Resources on page 10](#).

## Set the IP Address in the Programming Software

If you are not using network address translation (NAT), type the IP address of the module in the IP Address field. See the Allen-Bradley® Stratix® 5700 Network Address Translation (NAT) White Paper, publication [ENET-WP032](#), for more information on NAT.

If you are using NAT, follow these steps:

1. In the IP Address field, type the IP address of the controller.
2. To open the Advanced Ethernet Settings dialog box, click Advanced.



3. Check the checkbox to indicate that this module and the controller communicate through NAT devices.
4. Type the actual module address.  
If you configured the IP address with the rotary switches, this address is the address that you set on the module.
5. Click OK.

---

**IMPORTANT** When NAT is used in a safety application with a GuardLogix controller, the module does not accept a safety connection unless the actual module address is provided.

---

## Change the Module Definition

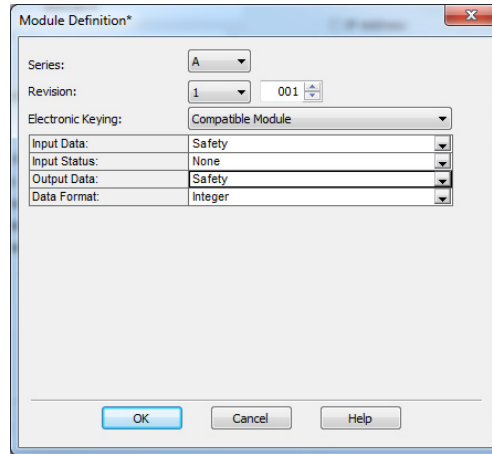
Click Change to open the Module Definition dialog box, where you can select values to configure what data and status tags to generate implicitly for the safety module.

See these sections for settings explanations:

- [Input Data Options on page 81](#)
- [Input Status Options on page 82](#)
- [Output Data Options on page 84](#)



- [Values and States of Tags on page 85](#)



*Input Data Options*

Choose from these options:

- Safety - Creates these tags for the target module:
  - RunMode: Module mode
  - ConnectionFaulted: Communication status
  - Safety Data: Safety inputs from module

[-] IB&xOBV8:I			AB:1791ES_IB&X...	Safety
[-] IB&xOBV8:I.RunMode			BOOL	Safety
[-] IB&xOBV8:I.ConnectionFaulted			BOOL	Safety
[-] IB&xOBV8:I.Pt00Data			BOOL	Safety
[-] IB&xOBV8:I.Pt01Data			BOOL	Safety
[-] IB&xOBV8:I.Pt02Data			BOOL	Safety
[-] IB&xOBV8:I.Pt03Data			BOOL	Safety
[-] IB&xOBV8:I.Pt04Data			BOOL	Safety
[-] IB&xOBV8:I.Pt05Data			BOOL	Safety
[-] IB&xOBV8:I.Pt06Data			BOOL	Safety
[-] IB&xOBV8:I.Pt07Data			BOOL	Safety

- Safety-Readback - This selection is not available for input-only safety modules. Safety-Readback creates both safety and readback tags. Readback indicates the presence of 24V on the output terminal.

[-] IB&xOBV8:I.Pt00Readback			BOOL	Safety
[-] IB&xOBV8:I.Pt01Readback			BOOL	Safety
[-] IB&xOBV8:I.Pt02Readback			BOOL	Safety
[-] IB&xOBV8:I.Pt03Readback			BOOL	Safety
[-] IB&xOBV8:I.Pt04Readback			BOOL	Safety
[-] IB&xOBV8:I.Pt05Readback			BOOL	Safety
[-] IB&xOBV8:I.Pt06Readback			BOOL	Safety
[-] IB&xOBV8:I.Pt07Readback			BOOL	Safety

### Input Status Options

Choose from these options.

---

**IMPORTANT** Status data is not SIL 3 data. Do not use status data to control a SIL 3 safety output.

---

- None - No status tags, only data for the inputs
- Point Status-Muting - A muting status tag for test output with muting output capability with point status for each input and output point

[-] IB&xOBV4_ES:I			AB:1791ES_IB8X...	Safety
[-] IB&xOBV4_ES:I.RunMode			BOOL	Safety
[-] IB&xOBV4_ES:I.ConnectionFaulted			BOOL	Safety
[-] IB&xOBV4_ES:I.Pt00Data			BOOL	Safety
[-] IB&xOBV4_ES:I.Pt01Data			BOOL	Safety
[-] IB&xOBV4_ES:I.Pt02Data			BOOL	Safety
[-] IB&xOBV4_ES:I.Pt03Data			BOOL	Safety
[-] IB&xOBV4_ES:I.Pt04Data			BOOL	Safety
[-] IB&xOBV4_ES:I.Pt05Data			BOOL	Safety
[-] IB&xOBV4_ES:I.Pt06Data			BOOL	Safety
[-] IB&xOBV4_ES:I.Pt07Data			BOOL	Safety
[-] IB&xOBV4_ES:I.Pt00InputStatus			BOOL	Safety
[-] IB&xOBV4_ES:I.Pt01InputStatus			BOOL	Safety
[-] IB&xOBV4_ES:I.Pt02InputStatus			BOOL	Safety
[-] IB&xOBV4_ES:I.Pt03InputStatus			BOOL	Safety
[-] IB&xOBV4_ES:I.Pt04InputStatus			BOOL	Safety
[-] IB&xOBV4_ES:I.Pt05InputStatus			BOOL	Safety
[-] IB&xOBV4_ES:I.Pt06InputStatus			BOOL	Safety
[-] IB&xOBV4_ES:I.Pt07InputStatus			BOOL	Safety
[-] IB&xOBV4_ES:I.Pt00OutputStatus			BOOL	Safety
[-] IB&xOBV4_ES:I.Pt01OutputStatus			BOOL	Safety
[-] IB&xOBV4_ES:I.Pt02OutputStatus			BOOL	Safety
[-] IB&xOBV4_ES:I.Pt03OutputStatus			BOOL	Safety
[-] IB&xOBV4_ES:I.Pt04OutputStatus			BOOL	Safety
[-] IB&xOBV4_ES:I.Pt05OutputStatus			BOOL	Safety
[-] IB&xOBV4_ES:I.Pt06OutputStatus			BOOL	Safety
[-] IB&xOBV4_ES:I.Pt07OutputStatus			BOOL	Safety
[-] IB&xOBV4_ES:I.Muting03Status			BOOL	Safety
[-] IB&xOBV4_ES:I.Muting07Status			BOOL	Safety
[-] IB&xOBV4_ES:I.OutputPowerStatus			BOOL	Safety
[-] IB&xOBV4_ES:I.InputPowerStatus			BOOL	Safety

- Combined Status-Muting
  - One BOOL tag represents an AND of the status bits for all input points. For example, if any input channel has a fault, this bit goes LO.<sup>(1)</sup>
  - One BOOL tag represents an AND of the status bits for all output points.<sup>(1)</sup>
  - A muting status tag for test output  
T3/T7 (for 1791ES-IB8XOBV4, 1732ES-IB8XOB8 and 1732ES-IB8XOBV4 modules)  
T3/T7/T11/T15 (for 1791ES-IB16 and 1732ES-IB16 modules),  
and  
T3/T7/T11 (for 1732ES-IB12XOB4 and 1732ES-IB12XOBV2 modules).

[-]	IB&xOBV4_ES:I		AB:1791ES_IB8X...	Safety
	IB&xOBV4_ES:I.RunMode		BOOL	Safety
	IB&xOBV4_ES:I.ConnectionFaulted		BOOL	Safety
	IB&xOBV4_ES:I.Pt00Data		BOOL	Safety
	IB&xOBV4_ES:I.Pt01Data		BOOL	Safety
	IB&xOBV4_ES:I.Pt02Data		BOOL	Safety
	IB&xOBV4_ES:I.Pt03Data		BOOL	Safety
	IB&xOBV4_ES:I.Pt04Data		BOOL	Safety
	IB&xOBV4_ES:I.Pt05Data		BOOL	Safety
	IB&xOBV4_ES:I.Pt06Data		BOOL	Safety
	IB&xOBV4_ES:I.Pt07Data		BOOL	Safety
	IB&xOBV4_ES:I.Muting03Status		BOOL	Safety
	IB&xOBV4_ES:I.Muting07Status		BOOL	Safety
	IB&xOBV4_ES:I.OutputPowerStatus		BOOL	Safety
	IB&xOBV4_ES:I.InputPowerStatus		BOOL	Safety
	IB&xOBV4_ES:I.CombinedOutputStatus		BOOL	Safety
	IB&xOBV4_ES:I.CombinedInputStatus		BOOL	Safety
[+]	IB&xOBV4_ES:O		AB:1791ES_IB8X...	Safety

(1) When using combined status, use Explicit Messaging to read individual point status for diagnostic purposes.

### Output Data Options

Choose from these options.

**IMPORTANT** The standard outputs on the module must not be used for safety purposes.

- None - Results in an input only connection to the module. Inputs and status are read, but no outputs are written.
- Safety - Creates the safety tags shown here and enables the safety outputs for use in the safety task.

[-] IB&xOBV4_ES:O		AB:1791ES_IB8X...	Safety
[-] IB&xOBV4_ES:O.Pt00Data		BOOL	Safety
[-] IB&xOBV4_ES:O.Pt01Data		BOOL	Safety
[-] IB&xOBV4_ES:O.Pt02Data		BOOL	Safety
[-] IB&xOBV4_ES:O.Pt03Data		BOOL	Safety
[-] IB&xOBV4_ES:O.Pt04Data		BOOL	Safety
[-] IB&xOBV4_ES:O.Pt05Data		BOOL	Safety
[-] IB&xOBV4_ES:O.Pt06Data		BOOL	Safety
[-] IB&xOBV4_ES:O.Pt07Data		BOOL	Safety

- Test - Creates these tags and enables the test outputs on the module. These outputs are standard outputs and must not be used for safety purposes.

[-] IB&xOBV4_ES:O		AB:1791ES_IB8X...	Safety
[-] IB&xOBV4_ES:O.Test00Data		BOOL	Safety
[-] IB&xOBV4_ES:O.Test01Data		BOOL	Safety
[-] IB&xOBV4_ES:O.Test02Data		BOOL	Safety
[-] IB&xOBV4_ES:O.Test03Data		BOOL	Safety
[-] IB&xOBV4_ES:O.Test04Data		BOOL	Safety
[-] IB&xOBV4_ES:O.Test05Data		BOOL	Safety
[-] IB&xOBV4_ES:O.Test06Data		BOOL	Safety
[-] IB&xOBV4_ES:O.Test07Data		BOOL	Safety

- Combined - Creates these tags and enables all module outputs - safety and test.

[-] IB&xOBV4_ES:O		AB:1791ES_IB8X...	Safety
[-] IB&xOBV4_ES:O.Pt00Data		BOOL	Safety
[-] IB&xOBV4_ES:O.Pt01Data		BOOL	Safety
[-] IB&xOBV4_ES:O.Pt02Data		BOOL	Safety
[-] IB&xOBV4_ES:O.Pt03Data		BOOL	Safety
[-] IB&xOBV4_ES:O.Pt04Data		BOOL	Safety
[-] IB&xOBV4_ES:O.Pt05Data		BOOL	Safety
[-] IB&xOBV4_ES:O.Pt06Data		BOOL	Safety
[-] IB&xOBV4_ES:O.Pt07Data		BOOL	Safety
[-] IB&xOBV4_ES:O.Test00Data		BOOL	Safety
[-] IB&xOBV4_ES:O.Test01Data		BOOL	Safety
[-] IB&xOBV4_ES:O.Test02Data		BOOL	Safety
[-] IB&xOBV4_ES:O.Test03Data		BOOL	Safety
[-] IB&xOBV4_ES:O.Test04Data		BOOL	Safety
[-] IB&xOBV4_ES:O.Test05Data		BOOL	Safety
[-] IB&xOBV4_ES:O.Test06Data		BOOL	Safety
[-] IB&xOBV4_ES:O.Test07Data		BOOL	Safety

### Values and States of Tags

This table shows the values and states of the tags.

**Table 22 - Values and States of Tags**

Data		Description
Input data	Run Mode STANDARD	Indicates whether a device actively updates consumed data that is in one of these states. • Run mode: 1 • Idle State: 0
	Connection Faulted STANDARD	Indicates the validity of the safety connection between the safety producer and the safety consumer. • Valid: 0 • Faulted: 1
	Safety Input Data SAFETY	Indicates the ON/OFF status of each input circuit. • ON: 1 • OFF: 0
	Combined Safety Input Status SAFETY	An AND of the status of all input circuits. • All circuits are normal: 1 • An error was detected in one or more input circuits: 0
	Individual Safety Input Status SAFETY	Indicates the status of each input circuit. • Normal: 1 • Fault (Alarm): 0
	Combined Safety Output Status SAFETY	An AND of the status of all safety output circuits. • All circuits are normal: 1 • An error has been detected in one or more output circuits: 0
	Individual Safety Output Status SAFETY	Indicates the status of each safety output circuit. • Normal: 1 • Fault (Alarm): 0
	Muting Lamp Status SAFETY	Indicates the status when a test output is configured as a muting lamp output. • Normal: 1 • Fault (Alarm): 0
	Safety Output Monitor STANDARD	Monitors the outputs of the safety output circuits. • ON: 1 • OFF: 0
	Individual Test Output Status STANDARD	Indicates the status of each of the test output circuits. • Normal: 1 • Fault (Alarm): 0
	Input Power Error Bit STANDARD	Indicates if the field power supplied is within specification. • Power error: 1 • Power OK: 0
	Output Power Error Bit STANDARD	Indicates if the field power supplied is within specification. • Power error: 1 • Power OK: 0
Output data	Safety Output Data SAFETY	Controls the safety output. • ON: 1 • OFF: 0
	Standard Output Data STANDARD	Controls the test output when test output mode is set to a standard output. • ON: 1 • OFF: 0

---

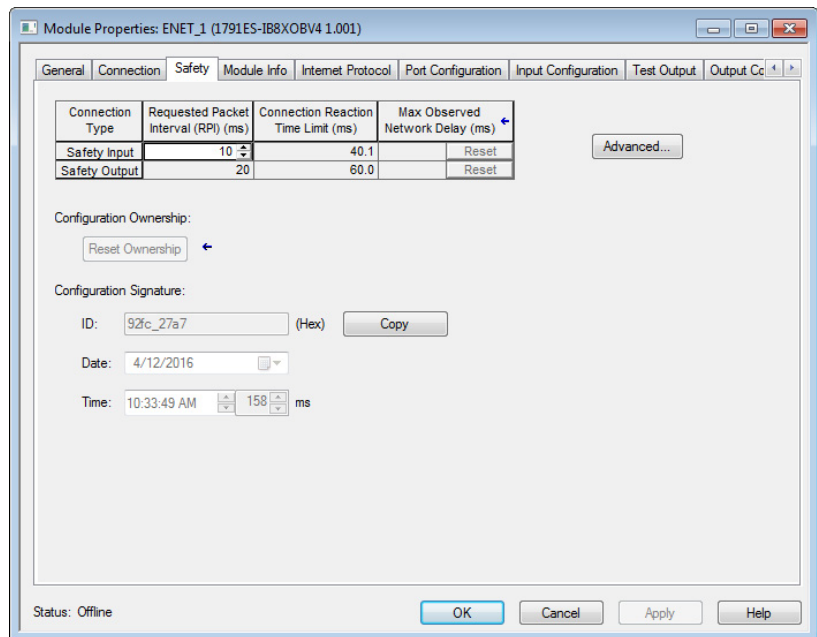
**IMPORTANT** Safety denotes information the controller can use in safety-related functions. Standard denotes additional information that must not be relied on for safety functions.

---

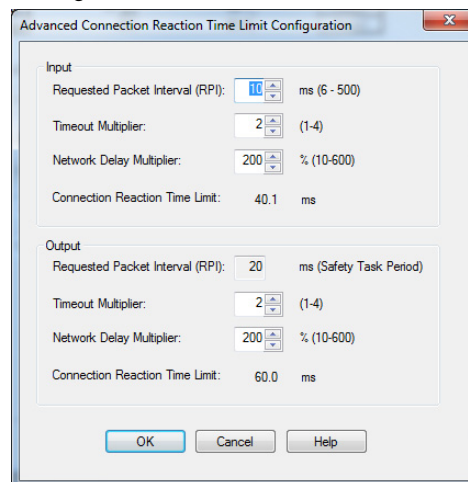
## Configure the Safety Connections

Follow these steps to complete entries when you choose the Safety tab.

1. From the Module Properties dialog box, choose the Safety tab to see the Safety dialog box.



2. Click Advanced to configure Requested Packet Interval (RPI) and Configure Connection Reaction Time Limit (CRTL).



We suggest that you keep the Timeout Multiplier and Network Delay Multiplier at their default values of 2 and 200.

See the GuardLogix Controllers User Manual, which is listed in the [Additional Resources on page 10](#), for more information about the CRTL.

Make sure that input RPI is set to match the need. The smallest input RPI allowed is 6 ms. Small RPIs consume network bandwidth and can cause nuisance trips because other devices cannot get access to the network.

As an example, a safety input module with only E-stop switches connected to it generally can work well with settings of 50...100 ms. An input module with a light curtain guarding a hazard can need the fastest response that is possible.

Appropriate RPI selection results in a system with maximum (best) performance.

**IMPORTANT** Analyze each safety channel to determine what is appropriate. The default timeout multiplier of 2 and network delay multiplier of 200 creates the following:

- An input connection reaction time limit of four times the RPI.
- An output connection reaction limit of three times the RPI.

A safety administrator must approve changes to these parameters.

Every connection has a connection status tag.

Connection Faulted

<input type="checkbox"/>	IB&xOBV4_ES:I		AB:1791ES_IB8X...	Safety
<input type="checkbox"/>	IB&xOBV4_ES:I.RunMode		BOOL	Safety
<input type="checkbox"/>	IB&xOBV4_ES:I.ConnectionFaulted		BOOL	Safety
<input type="checkbox"/>	IB&xOBV4_ES:I.Pt00Data		BOOL	Safety
<input type="checkbox"/>	IB&xOBV4_ES:I.Pt01Data		BOOL	Safety
<input type="checkbox"/>	IB&xOBV4_ES:I.Pt02Data		BOOL	Safety
<input type="checkbox"/>	IB&xOBV4_ES:I.Pt03Data		BOOL	Safety
<input type="checkbox"/>	IB&xOBV4_ES:I.Pt04Data		BOOL	Safety
<input type="checkbox"/>	IB&xOBV4_ES:I.Pt05Data		BOOL	Safety
<input type="checkbox"/>	IB&xOBV4_ES:I.Pt06Data		BOOL	Safety
<input type="checkbox"/>	IB&xOBV4_ES:I.Pt07Data		BOOL	Safety

If the RPI and CRTL for the network are set appropriately, then this status tag must always remain LO. Monitor all connection status bits to verify that they are not going HI intermittently due to timeouts.

### Configuration Ownership – Reset Ownership

The connection between the owner and the Guard I/O™ module is based on the following items:

- Guard I/O EtherNet/IP address
- Guard I/O safety network number
- GuardLogix slot number
- GuardLogix safety network number
- Path from GuardLogix controller to Guard I/O module
- Configuration signature

If any of these items change, the connection between the GuardLogix controller and the Guard I/O module is lost, and the yellow yield in the project tree appears. Reset ownership to re-establish the connection by using this procedure.

1. Open the safety I/O module properties.

2. Choose the Safety tab.
3. From the dialog box, choose Reset ownership.

### Configuration Signature

The programming software creates the configuration signature and the safety module verifies it. The configuration signature provides SIL 3 integrity of the configuration of a Guard I/O module.

- When a GuardLogix controller first connects to an unconfigured Guard I/O module, the complete configuration is downloaded to the I/O module.
- Any time the GuardLogix controller attempts to connect to a Guard I/O module, if the configuration signatures are the same, then the configuration does not need to be downloaded, because they already match.
- Any time the GuardLogix controller attempts to connect to a Guard I/O module and the signatures do not match, the module checks the IP address and safety network number. If these values are all correct, the controller attempts to configure the module.

### Configure the Module Inputs

[Table 23](#) shows the typical safety input parameters available on the Input Configuration tab. See [Chapter 1](#) for related information.

**Table 23 - Typical Safety Input Parameters**

Parameter Name	Value	Description
Input Point Operation Type	Single Channel	Inputs are treated as single channel.
	Dual-channel Equivalent	Inputs are treated as a dual-channel pair. The channels must match (be equal) within the discrepancy time or a fault is generated.
	Dual-channel Complementary	Inputs are treated as a dual-channel pair. The channels must disagree (be opposite) within the discrepancy time or a fault is generated.
Input Point Mode	Not Used	The input is disabled. It remains logic 0 if 24V is applied to the input terminal.
	Safety Test Pulse	Pulse testing is performed on this input circuit. A test source on the module must be used as the 24V source for this circuit. The test source is configured by using the test source pull-down. The pulse test detects shorts to 24V, and channel-to-channel shorts to other inputs.
	Safety	A safety input is connected but there is no requirement for the 1791ES module to perform a pulse test on this circuit. An example is a safety device that performs its own pulse tests on the input wires, such as a light curtain.
	Standard	A standard device, such as a reset switch, is connected. This point cannot be used in dual channel operation.
Safety Input Test Source	None	If pulse testing is being performed on an input point, then the test source that is sourcing the 24V for the input circuit must be selected. If the incorrect test source is entered, the result is pulse test failures on that input circuit.
	Test Output 0	
	Test Output 1	
	Test Output 2	
	Test Output 3	
	Test Output 4...15 <sup>(1)</sup>	
Input Delay Time Off -> On	0...126 ms (in increments of 6 ms)	Filter time is for OFF to ON transition. Input must be high after input delay has elapsed before it is set logic 1.
Input Delay Time On -> Off	0...126 ms (in increments of 6 ms)	Filter time is ON to OFF transition. Input must be low after input delay has elapsed before it is set logic 0.



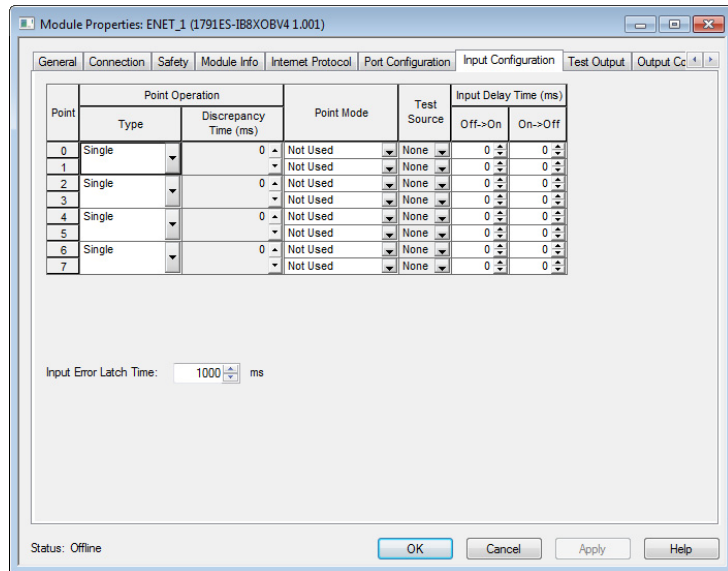
**Table 23 - Typical Safety Input Parameters (Continued)**

Parameter Name	Value	Description
Safety Input Error Latch Time	0 . . 65,530 ms (in increments of 10 ms)	Default is 1000 ms. The purpose for latching input errors is to make sure that intermittent faults that can only exist for a few milliseconds are latched long enough for the controller to read. The amount of time to latch the error must be based on the RPI, the safety task watchdog, and other application-specific variables.

(1) There are eight test outputs on 1791ES-IB8X0BV4, 1732ES-IB8X0B8 and 1732ES-IB8X0BV4 modules, 16 test outputs on 1791ES-IB16 and 1732ES-IB16 modules, and 12 test outputs on 1732ES-IB12X0B4 and 1732ES-IB12X0BV2 modules.

Follow these steps to configure the module inputs.

1. Click the Input Configuration tab.



2. For Point Operation Type, choose one of these values and a value for Discrepancy Time if set to Equivalent or Complementary:
  - Single  
Inputs are treated as single channels. In many cases, dual-channel safety inputs are configured as two individual single channels. This configuration does not affect pulse testing because it is handled on an individual channel basis.
  - Equivalent<sup>(1)</sup>  
Inputs are treated as a dual-channel pair. The channels must match within the discrepancy time or an error is generated.
  - Complementary<sup>(1)</sup>  
Inputs are treated as a dual-channel pair. They must be in opposite states within the discrepancy time or an error is generated.
3. For Point Mode, choose one of these values for each point and refer to the Safety Input Parameters table for additional information:
  - Not Used - Safety input channel is disabled
  - Safety Pulse Test - Safety input is configured for pulse test operation
  - Safety - The safety input is used with a safety field device

(1) If you configure discrepancy time on safety I/O modules, it masks input inconsistent faults from the GuardLogix safety instructions. GuardLogix can read status to obtain this fault information.

- Standard - Safety input has a standard field device that is wired to it
4. Complete entries, and note the following:
    - For each safety input on the module, you can define if the input is pulse tested. If the inputs are pulse tested, select which test source to use.
    - Off -> On and On -> Off delay times can be configured per channel with each channel tuned to match the characteristics of the field device for maximum performance.
    - Input Error Latch Time is the time that the module holds an error to make sure that the controller can detect it. This setting provides you more reliable diagnostics and enhances the chances that a nuisance error is detected.
  5. Click OK at the bottom of the dialog box or a tab at the top of the dialog box.

## Configure the Test Outputs

[Table 24](#) provides information for configuring the test outputs.

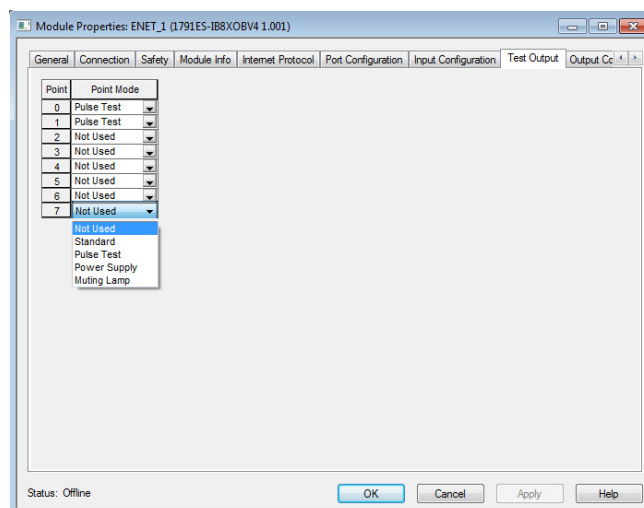
**Table 24 - Configuring Test Outputs**

Parameter Name	Value	Description	Default
Test Output Mode	Not Used	The test output is disabled.	Not Used
	Standard	The output point is enabled for use by the GuardLogix controller.	
	Pulse Test	The test output is being used as a pulse test source.	
	Power Supply	A constant 24V is placed on the output terminal. It can be used to provide power to a field device.	
	Muting Lamp Output <sup>(1)</sup>	An indicator lamp is connected to the output. When this lamp is energized, a burned-out bulb, broken wire, or short to GND error condition can be detected. Typically, the lamp is an indicator that is used in light curtain applications.	

(1) Terminal T3/T7 for 1791ES-IB8XOBV4, 1732ES-IB8XOB8 and 1732ES-IB8XOBV4 modules, terminal T3/T7/T11/T15 for 1791ES-IB16 and 1732ES-IB16 modules, and terminal T3/T7/T11 for 1732ES-IB12XOB4 and 1732ES-IB12XOBV2 modules.

Follow these steps to configure the test outputs.

1. Click the Test Outputs tab.



- From the Port Mode pull-down menus, select the desired configuration option for each point.

## Configure the Module Outputs

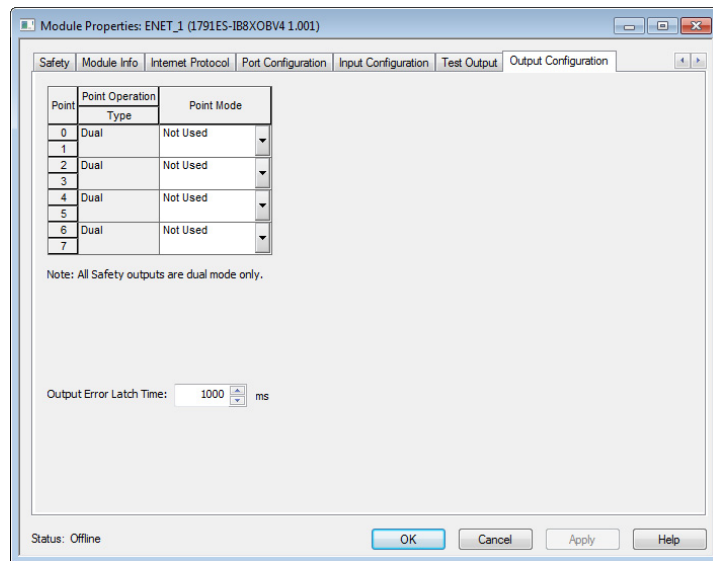
[Table 25](#) provides information for configuring the test outputs.

**Table 25 - Guidelines for Configuring Safety Outputs**

Parameter Name	Value	Description	Default
Point Operation Type	Dual	The 1791ES modules, the 1732ES-IB12XOBV2 module, and the 1732ES-IB8XOBV4 module treat the outputs as a pair. It always sets them HI to LO as a matched pair. Safety logic must set both of these outputs ON or OFF simultaneously or the module declares a channel fault.	Dual-channel
	Single	The 1732ES-IB12XOB4 module can be configured with the outputs treated as single channels. Both channels of an output pair are set to either Single or Dual.	
Point Mode	Not Used	The output is disabled.	Not Used
	Safety	The output point is enabled, and it does not perform a pulse test on the output.	
	Safety Pulse Test	The output point is enabled and performs a pulse test on the output. When the output is energized, the output pulses LO briefly. The pulse test detects if 24V remains on the output terminal during this LO pulse due to a short to 24V. The pulse test also detects if the output is shorted to another output terminal.	
Output Error Latch Time	0 . . 65,530 ms (in increments of 10 ms)	The purpose for latching output errors is to make sure that intermittent faults that can only exist for a few milliseconds are latched long enough for the controller to read. The amount of time to latch the errors is based on the RPI, the safety task watchdog, and other application-specific variables.	1000 ms

Follow these steps to configure the module outputs.

- For Point Operation, select single or dual.



- For Point Mode, select Not Used, Safety, or Safety Pulse Test. See the Safety Output Parameters table for additional information.
- Select a value for Output Error Latch Time. Output Error Latch Time is the time that the module holds an error to make sure that the controller can detect it. This setting provides you more reliable diagnostics and enhances the changes that a nuisance error is detected.
- Click Apply from the bottom of the dialog box.

## Save and Download the Module Configuration

We recommend that after a module is configured you save your work.

If after downloading the program the MS and NS indicators on the Guard I/O module are not both solid green, this state can be due to loss of ownership. The ownership is based on the following items:

- Guard I/O EtherNet/IP address
- Guard I/O safety network number
- GuardLogix slot number
- GuardLogix safety network number
- Path from GuardLogix controller to Guard I/O module
- Configuration signature

If any of these items change, the connection between the GuardLogix controller and the Guard I/O module is lost, and the yellow yield in the project tree appears. Reset ownership to re-establish the connection by using this procedure.

1. Open the safety I/O module properties.
2. Choose the Safety tab.
3. From the dialog box, choose Reset ownership.

## Replace Guard I/O Modules

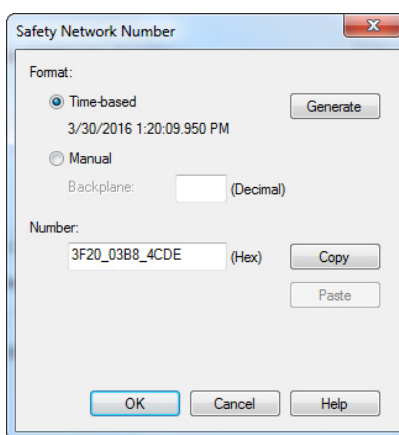
Topic	Page
Manually Set the Safety Network Number	93
Reset the Module to Out-of-box Configuration	94
Replace a Module in a GuardLogix System	94

GuardLogix® controllers retain I/O module configuration onboard and are able to download the configuration to the replacement module. Replacing a safety I/O module that sits on a CIP Safety network is more complicated than replacing standard devices because of the safety network number (SNN). The module number and SNN constitute the DeviceID of the safety module. Safety devices require this more complex identifier to make sure that duplicate module numbers do not compromise communication between the correct safety devices.

### Manually Set the Safety Network Number

The following statement applies if a safety signature exists. The POINT Guard I/O™ module must have a proper SNN/node number identification that matches the module within the safety controller project before it can receive its configuration. To keep integrity, the SNN setting of the module is required to be a manual action. This manual action is to use the 'set' function on an out-of-box POINT Guard I/O module.

**Figure 32 - Setting the SNN with a GuardLogix Controller**



## Reset the Module to Out-of-box Configuration

If a Guard I/O module was used previously, clear the existing configuration before installing it on a safety network.

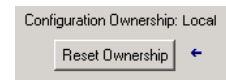
When the programming software is online, the Safety tab of the Module Properties dialog box displays the current configuration ownership. When the opened project owns the configuration, Local is displayed. When a second device owns the configuration, Remote is displayed, along with the safety network number (SNN), and node address or slot number of the configuration owner. Communication error is displayed if the module read fails.

If the connection is Local, you must inhibit the module connection before you reset ownership. To inhibit the module:

1. Right-click the module and choose Properties.
2. Click the Connection tab.
3. Check the inhibit module checkbox.
4. Click Apply and then OK.

Follow these steps to reset the module to its out-of-box configuration when online.

1. Right-click the module and choose Properties.
2. Click the Safety tab.
3. Click Reset Ownership.



## Replace a Module in a GuardLogix System

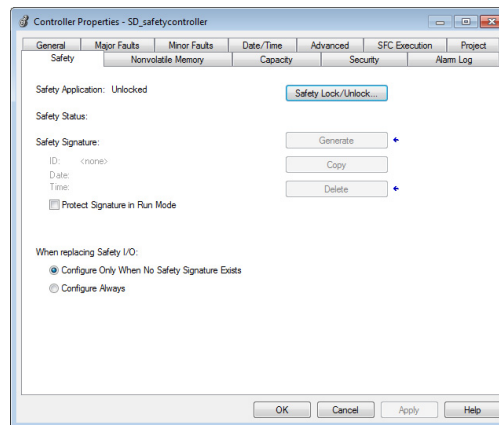
The replacement of safety devices requires that the replacement device is configured properly and that the operation of the replacement device is user-verified.



**ATTENTION:** During replacement or functional testing of a device, the safety of the system must not rely on any portion of the affected device.

Two options for I/O device replacement are available on the Safety tab of the Controller Properties dialog box in the programming software:

- Configure Only When No Safety Signature Exists
- Configure Always

**Figure 33 - Safety I/O Replacement Options**

## Configure Only When No Safety Signature Exists

This setting instructs the GuardLogix controller to configure a safety device only when the safety task does not have a safety task signature. The replacement device must also be in an out-of-box condition, meaning that a safety network number does not exist in the safety device.

If the safety task has a safety task signature, the GuardLogix controller only automatically configures the replacement CIP Safety I/O device if the following is true:

- The device already has the correct safety network number.
- The device electronic keying is correct.
- The node or IP address is correct.

For detailed information, see the appropriate GuardLogix Safety Reference Manual, which is listed in the [Additional Resources on page 10](#).

## Configure Always

The GuardLogix controller always attempts to configure a replacement CIP Safety I/O device if the device is in an out-of-box condition. This occurrence means that a safety network number does not exist in the replacement safety device and the node number and I/O device keying matches the configuration of the controller.



**ATTENTION:** Enable the Configure Always feature only if the entire routable CIP Safety control system is not being relied on to maintain SIL 3 behavior during the replacement and functional testing of a device.

If other parts of the CIP Safety control system are being relied upon to maintain SIL 3, make sure that the controller's Configure Always feature is disabled.

It is your responsibility to implement a process to make sure proper safety functionality is maintained during device replacement.

---



**ATTENTION:** Do not place any devices in the out-of-box condition on any CIP Safety network when the Configure Always feature is enabled, except while following the device replacement procedure in the appropriate GuardLogix Safety Reference Manual, which is listed in the [Additional Resources on page 10](#).

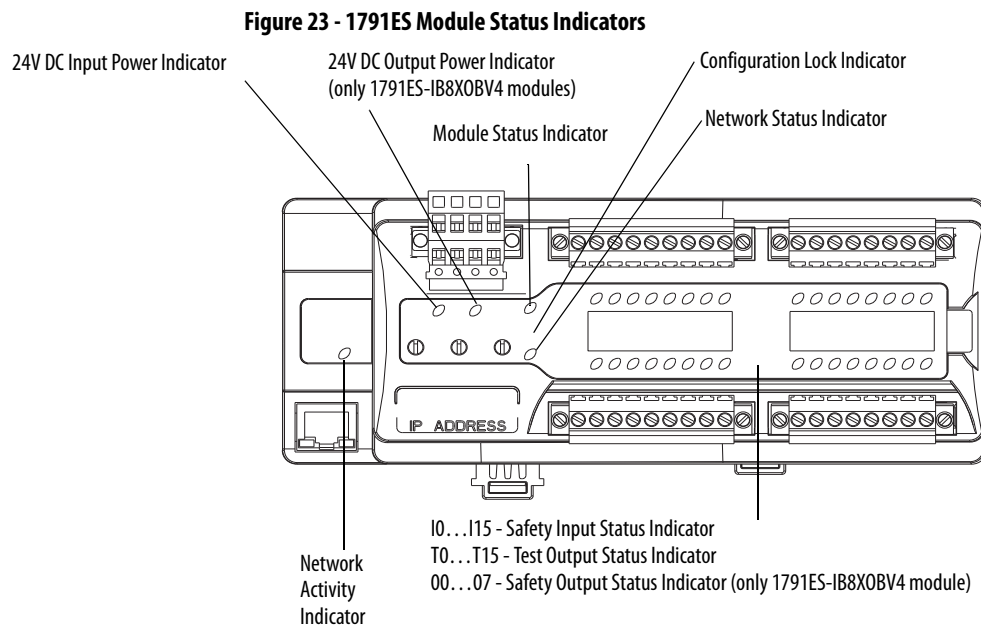
---



## Interpret the Module Status Indicators

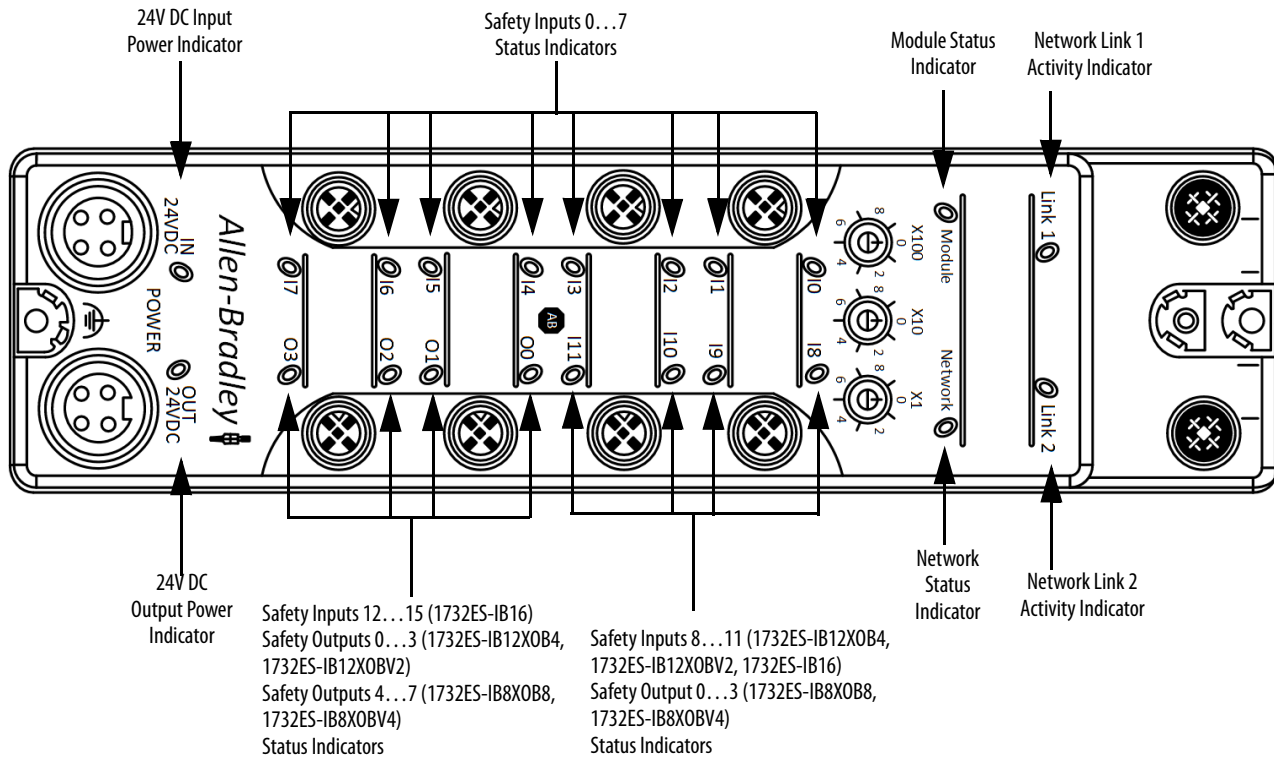
### Module Status Indicator Depictions

See [Figure 23](#) and [Table 26...Table 33](#) for information on the 1791ES module indicators.



See [Figure 34](#) and [Table 26...Table 33](#) for information on the 1732ES module status indicators.

Figure 34 - 1732ES Module Status Indicators



## Module Status Indicator Descriptions

Table 26 - 24V DC Input Power Indicator

State	Status	Description	Recommended Action
Off	No power	No power is applied. No input power or severe input power overvoltage. <sup>(1)</sup>	Apply power to this section. Apply power that is within specifications to this section. <sup>(2)</sup>
Solid green	Normal operation	The applied voltage is within specifications.	None.
Solid yellow	Input power out of specification	The input power is out of specification.	Check your connectors, wiring, and voltages.

(1) This description applies to only the 1732ES modules.

(2) This recommended action applies to only the 1732ES modules.

Table 27 - 24V DC Output Power Indicator

State	Status	Description	Recommended Action
Off	No power	No power is applied. No output power or severe output power overvoltage. <sup>(1)</sup>	Apply power to this section. Apply power that is within specifications to this section. <sup>(2)</sup>
Solid green	Normal operation	The applied voltage is within specifications.	None.
Solid yellow	Output power out of specification	The output power is out of specification.	Check your connectors, wiring, and voltages.

(1) This description applies to only the 1732ES modules.

(2) This recommended action applies to only the 1732ES modules.

**Table 28 - Module Status Indicator**

State	Status	Description	Recommended Action
Off	No power	No power is applied to the power connector. No power is applied to the input power connector or severe input power overvoltage. <sup>(1)</sup>	Apply power to this connector. Apply input power that is within specification to the module. <sup>(2)</sup>
Solid green	Normal operation	The module is operating normally.	None.
Solid red	Unrecoverable fault	The module detected an unrecoverable fault.	Cycle power to the module. If problem persists, replace the module.
Flashing red and green	Module is unconfigured	Module needs commissioning due to missing, incomplete, or incorrect configuration.	Reconfigure the module. For additional information, inspect Network Status indicator.
	Device in self-test	The module is performing its power-cycle diagnostic tests.	Wait for the module to complete its power-cycle diagnostics.
Flashing green	Idle	Idle, waiting for connection from scanner.	Establish connection.
Flashing red	Recoverable fault	The module has detected a recoverable fault.	Cycle power to the module or reset the module.
	User-initiated firmware update in progress	User-initiated firmware update is in progress.	Wait for firmware update to complete.

(1) This description applies to only the 1732ES modules.

(2) This recommended action applies to only the 1732ES modules.

**Table 29 - Network Status Indicator**

State	Status	Description	Recommended Action
Off	Module not online	The module does not have an IP address.	Verify that your network is working properly.
Flashing green	Module online with no connections in established state	The module has acquired an IP address, but no connections are established.	Verify your network and module configuration.
Solid green	Module online with connections in established state	The module is operating normally.	None.
Flashing red	One or more I/O connections in timed-out state	The module detected a recoverable network fault.	Verify your network and module configuration.
	User-initiated firmware update	User-initiated firmware update is in progress.	Wait for firmware update to complete.
Solid red	Critical link failure	The module detected an error that prevents it from communicating on the network, such as duplicate IP address has been detected.	Cycle power to the module. Check network IP addressing.
Flashing red and green	Self-test	The module is performing its power-cycle diagnostic test.	Wait for the module to complete its power-cycle diagnostics.
	Waiting for TUNID <sup>(1)</sup>	The module has received the proposed UNID and is waiting for the TUNID. <sup>(2)</sup>	None. <sup>(3)</sup>

(1) This status applies to only the 1732ES modules.

(2) This description applies to only the 1732ES modules.

(3) This recommended action applies to only the 1732ES modules.

**Table 30 - Network Activity Indicators (link 1 and link2)**

State	Status	Recommended Action
Off	No link is established.	Establish link.
Flashing Green	Transmit or receive activity.	None.
Steady Green	Link is established	None.

**Table 31 - Test Output Status Indicator (only 1791ES Modules)**

State	Status	Description	Recommended Action
Off	Test output off	The test output is off or the channel is configured for not used.	Turn on the test output or reconfigure the channel, if desired.
Solid yellow	Output on	Output is on.	None.
Solid red	Fault detected	A fault in the external wiring or input circuit detected.	Check field wiring. If no problem found, replace module. For outputs that are configured for muting, this could indicate undercurrent or burned-out lamp.

**Table 32 - Safety Input Status Indicator**

State	Status	Description	Recommended Action
Off	Safety input off	The safety input is off or the channel is configured for not used.	Turn on the safety input or reconfigure the channel, if desired.
Solid yellow	Safety input on	The safety input is on.	None.
Solid red	Fault detected	A fault in the external wiring or input circuit detected.	Check configuration, field wiring, and devices. If no problem found, replace module.
Flashing red	Partner fault detected	A fault in the partner input circuit of a dual-input configuration detected.	Check the field wiring and verify your configuration for the partner circuit. If no problem found, replace module.

**Table 33 - Safety Output Status Indicator (only 1732ES and 1791ES-IB8X0BV4 Modules)**

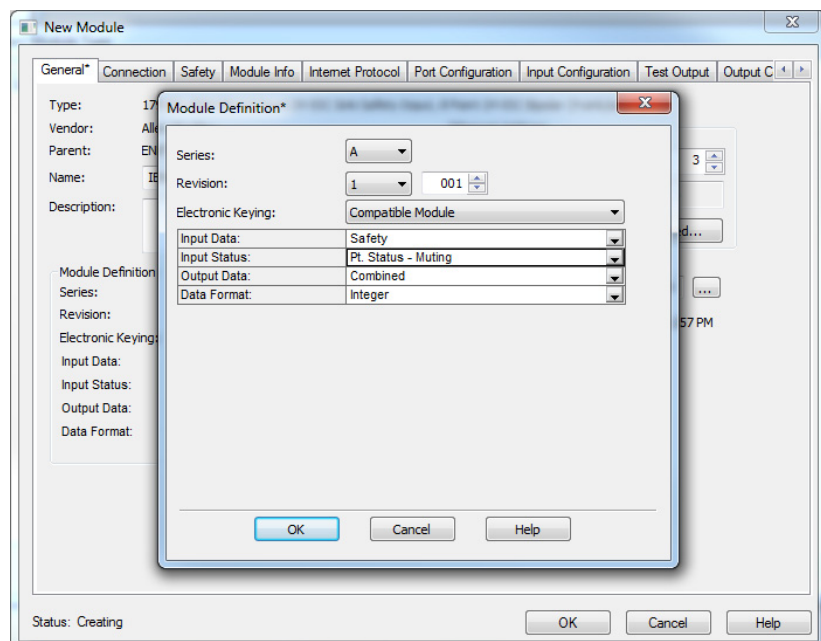
State	Status	Description	Recommended Action
Off	Safety output off	The safety output is off or the channel is configured for not used.	Turn on the safety output or reconfigure the channel, if desired.
Solid yellow	Safety output on	The safety output is on.	None.
Solid red	Fault detected	A fault in the output circuit was detected.	Check the circuit wiring and end device. If no problem found, replace module.
		Both tags in a dual channel circuit do not have the same value.	Make sure that logic is driving tag values to the same state (off or on).
Flashing red	Partner fault detected	A fault in the partner output circuit of a dual output configuration was detected.	Check the circuit wiring and end device of the partner. If no problem found, replace module.

## Get Diagnostic Status from Modules by Using Explicit Messaging

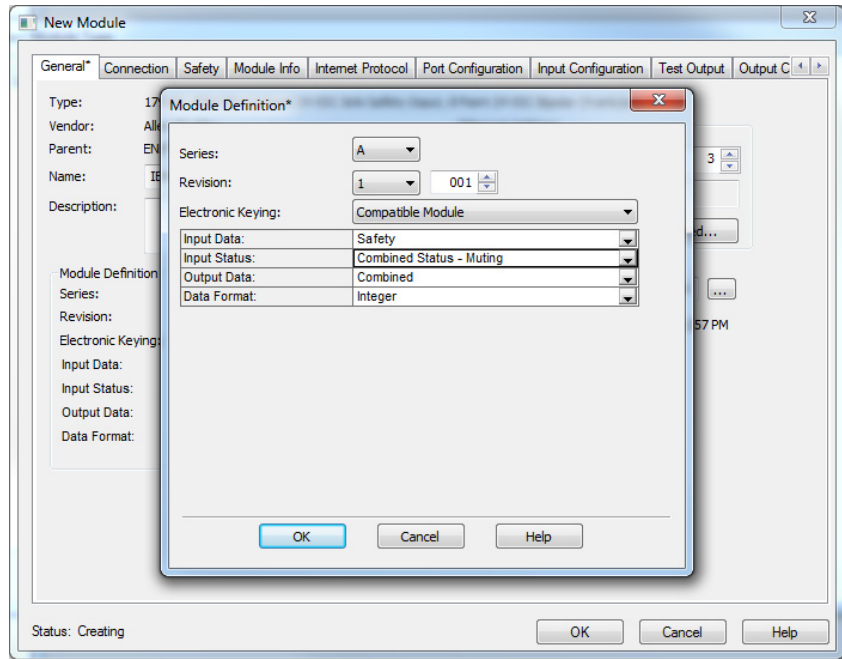
Topic	Page
Get Status Messages from 1791ES-IB8X0BV4 Modules	102
Get Status Messages from 1791ES-IB16 Modules	107
Get Status Messages from 1732ES Modules	112
I/O Data Supported by Each Module	136
I/O Assembly and Reference Data	140
Explicit Messages	149

This appendix provides information about how to use CIP Generic Message instructions (sometimes called Explicit Messaging) to get diagnostic status information from the modules.

You can implicitly obtain individual point status of the Guard I/O™ module from the Module Definition dialog box by choosing Pt. Status from the Input Status pull-down menu.



Another choice is to obtain overall status implicitly from the Module Definition dialog box by choosing Combined Status from the Input Status pull-down menu.

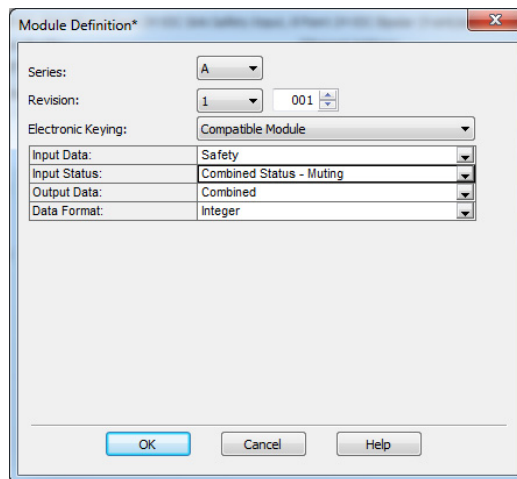


If the Combined Status changes, use Explicit Messaging to obtain the point level status.

## Get Status Messages from 1791ES-IB8XOBV4 Modules

Follow these steps to get status messages from 1791ES-IB8XOBV4 modules.

1. In the Module Definition dialog box, from the Input Status pull-down menu, choose Combined Status.



This selection creates a two-byte input assembly, as shown for the 1791ES-IB8XOBV4 module.

IB8xOBV4:1	{...}
IB8xOBV4:1.RunMode	0
IB8xOBV4:1.ConnectionFaulted	0
IB8xOBV4:1.Pt00Data	0
IB8xOBV4:1.Pt01Data	0
IB8xOBV4:1.Pt02Data	0
IB8xOBV4:1.Pt03Data	0
IB8xOBV4:1.Pt04Data	0
IB8xOBV4:1.Pt05Data	0
IB8xOBV4:1.Pt06Data	0
IB8xOBV4:1.Pt07Data	0
IB8xOBV4:1.Muting03Status	0
IB8xOBV4:1.Muting07Status	0
IB8xOBV4:1.OutputPowerStatus	0
IB8xOBV4:1.InputPowerStatus	0
IB8xOBV4:1.CombinedOutputStatus	0
IB8xOBV4:1.CombinedInputStatus	0

- Use the CombinedInputStatus and CombinedOutputStatus bits to detect if one or more of the I/O points on the module have a fault.
  - If any input or output status bit goes to a value of 0 (0=error, 1=no error), use the CombinedInputStatus and CombinedOutputStatus bits to condition your MSG rungs as follows.
  - The second rung can be used to read the status on mode transition and once a fault is detected, continue reading until the fault is corrected.
  - Place these rungs in the standard task.

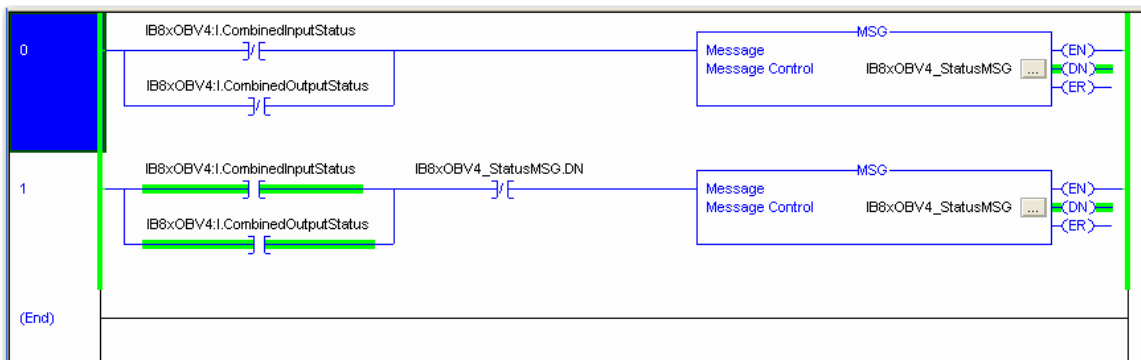
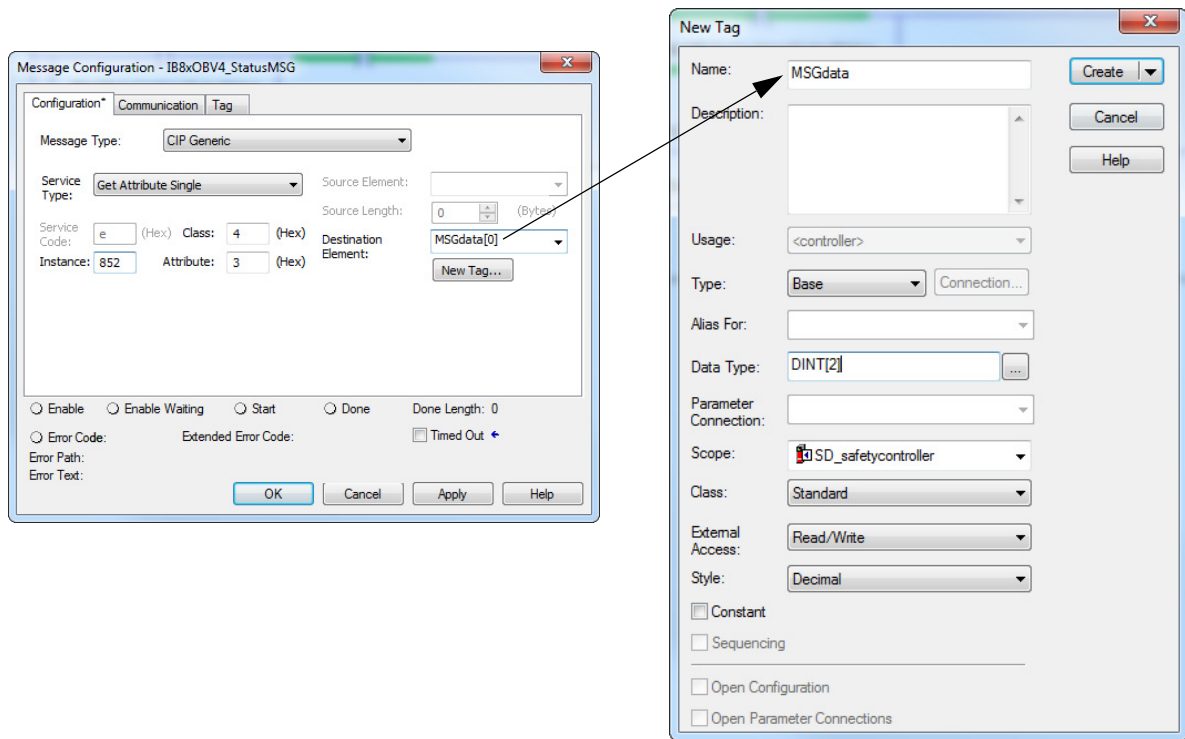


Figure 35...Figure 39 show the MSG instruction parameters to read Instance 852 from the 1791ES-IB8XOBV4 module.

Figure 35 - Instance 852 Configuration Tab



Instance 852 (354 hex) is 5 bytes in length, so the destination tag MSGdata must be at least 5 bytes in length to hold this data. The size is DINT[2] or 8 bytes (see Table 34).

Table 34 - Layout of Instance 852 (354 hex) – 1791ES-IB8XOBV4 Module

Instance Hex (decimal)	Connection Type	Byte	Bit 7	Bit 6	Bit 5	Bit 4	Bit 3	Bit 2	Bit 1	Bit 0
354 (852)	Safety and standard	0	Safety Input 7	Safety Input 6	Safety Input 5	Safety Input 4	Safety Input 3	Safety Input 2	Safety Input 1	Safety Input 0
		1	Safety Input 7 Status	Safety Input 6 Status	Safety Input 5 Status	Safety Input 4 Status	Safety Input 3 Status	Safety Input 2 Status	Safety Input 1 Status	Safety Input 0 Status
		2	Safety Output 7 Status	Safety Output 6 Status	Safety Output 5 Status	Safety Output 4 Status	Safety Output 3 Status	Safety Output 2 Status	Safety Output 1 Status	Safety Output 0 Status
		3	Safety Output 7 Monitor	Safety Output 6 Monitor	Safety Output 5 Monitor	Safety Output 4 Monitor	Safety Output 3 Monitor	Safety Output 2 Monitor	Safety Output 1 Monitor	Safety Output 0 Monitor
		4	Reserved	Reserved	Input Power Error <sup>(1)</sup>	Output Power Error <sup>(1)</sup>	Reserved	Reserved	Muting Lamp 7 Status	Muting Lamp 3 Status

(1) This data is only diagnostic data. This data does not have safety integrity.

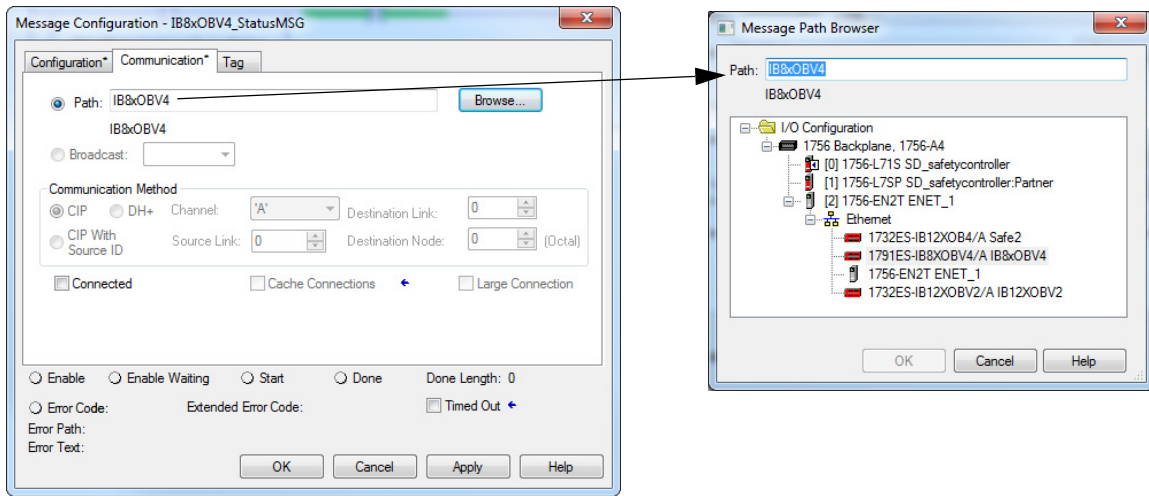
3. Click the Communication tab.

This dialog box requires the path to the module.

4. Click Browse to select the module that the MSG reads.

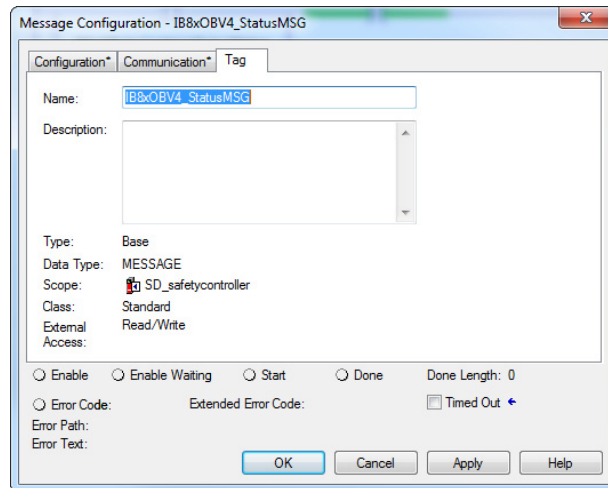


**Figure 36 - Instance 852 Communication Tab**



5. From the top of the Message Configuration dialog box, choose Tag.

**Figure 37 - Instance 852 Tag Tab**



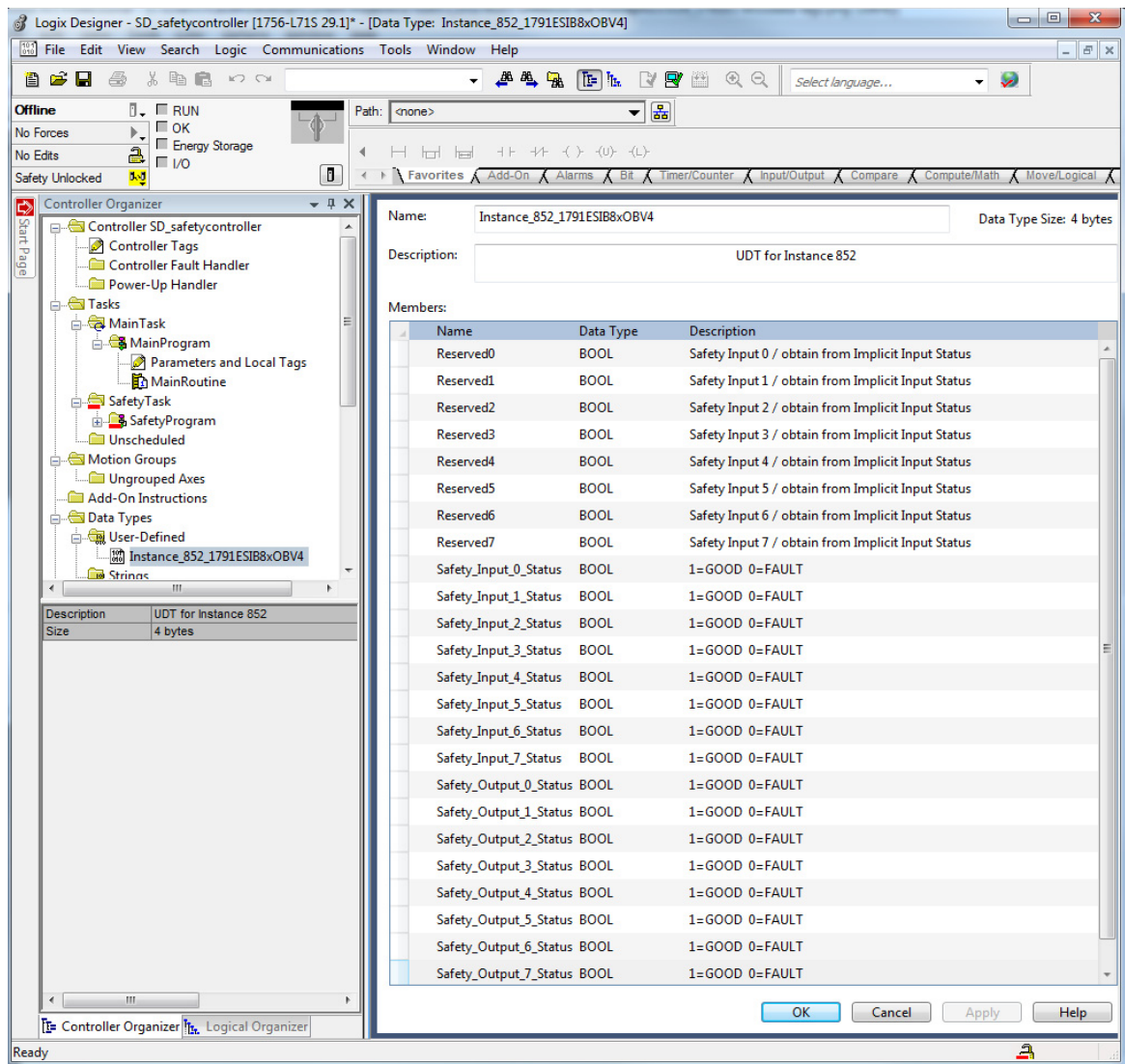
When the explicit message reads the data from the 1791ES-IB8XOBV4 module, the data appears in the MSGdata tags as shown in [Figure 38](#).

**Figure 38 - Instance 852 MSGdata Tags**

MSGdata	{...}	{...}	Decimal	DINT[2]
MSGdata[0]	16776960		Decimal	DINT
MSGdata[1]	19		Decimal	DINT
MSGdata[1].0	1		Decimal	BOOL
MSGdata[1].1	1		Decimal	BOOL
MSGdata[1].2	0		Decimal	BOOL
MSGdata[1].3	0		Decimal	BOOL
MSGdata[1].4	1		Decimal	BOOL
MSGdata[1].5	0		Decimal	BOOL
MSGdata[1].6	0		Decimal	BOOL
MSGdata[1].7	0		Decimal	BOOL

The first 32 bits of the instance are in MSGdata[0].0...31, and the final 8 bits are in MSGdata[1].0...7. These 40 bits must be mapped according to Instance 852. An easy method to do this mapping is to create a user-defined tag (UDT) for Instance 852. Once complete, it appears as shown in [Figure 39](#).

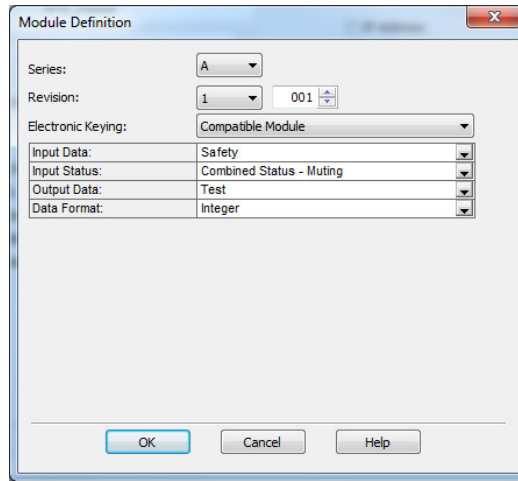
**Figure 39 - Instance 852 UDT**



## Get Status Messages from 1791ES-IB16 Modules

Follow these steps to get status messages from 1791ES-IB16 modules.

1. In the Module Definition dialog box, from the Input Status pull-down menu, choose Combined Status.



This selection creates a three-byte input assembly, as shown, for the 1791ES-IB16 module.

[-] IB16:I	{...}
[-] IB16:I.RunMode	0
[-] IB16:I.ConnectionFaulted	0
[-] IB16:I.Pt00Data	0
[-] IB16:I.Pt01Data	0
[-] IB16:I.Pt02Data	0
[-] IB16:I.Pt03Data	0
[-] IB16:I.Pt04Data	0
[-] IB16:I.Pt05Data	0
[-] IB16:I.Pt06Data	0
[-] IB16:I.Pt07Data	0
[-] IB16:I.Pt08Data	0
[-] IB16:I.Pt09Data	0
[-] IB16:I.Pt10Data	0
[-] IB16:I.Pt11Data	0
[-] IB16:I.Pt12Data	0
[-] IB16:I.Pt13Data	0
[-] IB16:I.Pt14Data	0
[-] IB16:I.Pt15Data	0
[-] IB16:I.Muting03Status	0
[-] IB16:I.Muting07Status	0
[-] IB16:I.Muting11Status	0
[-] IB16:I.Muting15Status	0
[-] IB16:I.InputPowerStatus	0
[-] IB16:I.CombinedInputStatus	0

2. Use the CombinedInputStatus bit to detect if one or more of the I/O points on the module have a fault.
  - If any input status bits go to a value of 0 (0 = bad; 1 = good), use an explicit message to determine which individual data points have faulted.

- You can use the second rung to read the status on mode transition and once a fault is detected, continue reading until the fault is corrected.
- Place these rungs in the standard task.

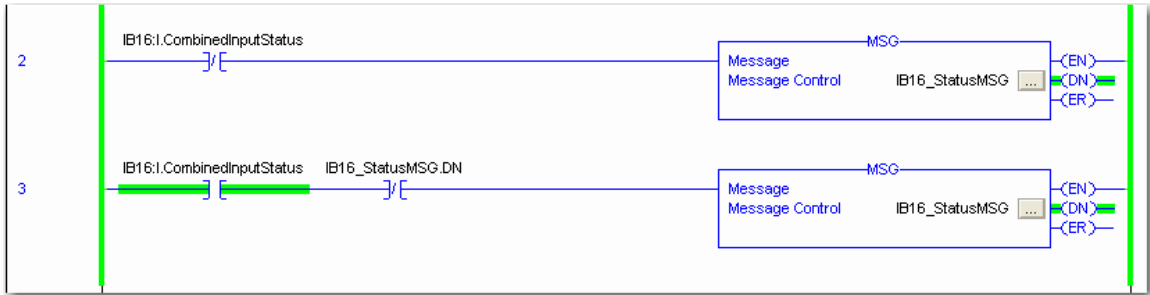
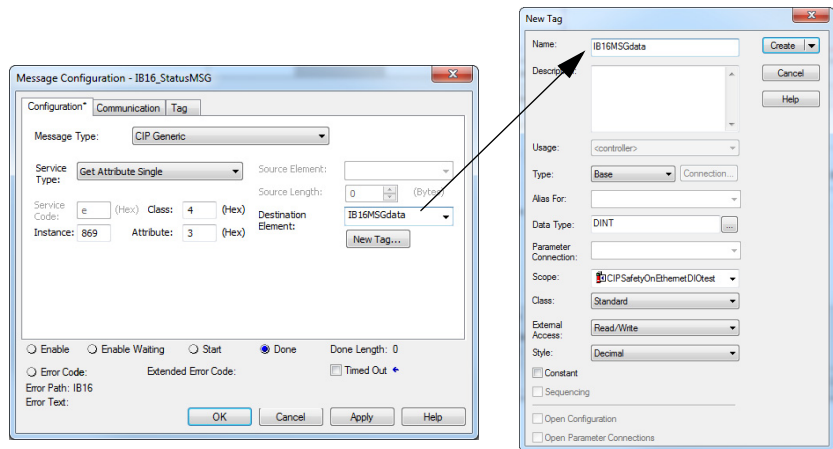


Figure 40...Figure 44 show the MSG instruction parameters for to read Instance 869 from the 1791ES-IB16 module. See Appendix C of this manual for a layout of possible instances.

Figure 40 - Instance 869 Configuration Tab Configuration



Instance 869 (365 hex) is 7 bytes in length, so the destination tag IB16MSGdata must be at least 7 bytes in length to hold this data. The size is DINT[2] or 8 bytes (see [Table 35](#)).

**Table 35 - Layout of Instance 869 (365 hex) – 1791ES-IB16 Module**

Instance Hex (decimal)	Connection Type	Byte	Bit 7	Bit 6	Bit 5	Bit 4	Bit 3	Bit 2	Bit 1	Bit 0
365 (869)	Safety and standard	0	Safety Input 7	Safety Input 6	Safety Input 5	Safety Input 4	Safety Input 3	Safety Input 2	Safety Input 1	Safety Input 0
		1	Safety Input 15	Safety Input 14	Safety Input 13	Safety Input 12	Safety Input 11	Safety Input 10	Safety Input 9	Safety Input 8
		2	Safety Input 7 Status	Safety Input 6 Status	Safety Input 5 Status	Safety Input 4 Status	Safety Input 3 Status	Safety Input 2 Status	Safety Input 1 Status	Safety Input 0 Status
		3	Safety Input 15 Status	Safety Input 14 Status	Safety Input 13 Status	Safety Input 12 Status	Safety Input 11 Status	Safety Input 10 Status	Safety Input 9 Status	Safety Input 8 Status
		4	Test Output 7 Status	Test Output 6 Status	Test Output 5 Status	Test Output 4 Status	Test Output 3 Status	Test Output 2 Status	Test Output 1 Status	Test Output 0 Status
		5	Test Output 15 Status	Test Output 14 Status	Test Output 13 Status	Test Output 12 Status	Test Output 11 Status	Test Output 10 Status	Test Output 9 Status	Test Output 8 Status
		6	Reserved	Reserved	Input Power Error <sup>(1)</sup>	Output Power Error <sup>(1)</sup>	Muting Lamp 15 Status	Muting Lamp 11 Status	Muting Lamp 7 Status	Muting Lamp 3 Status

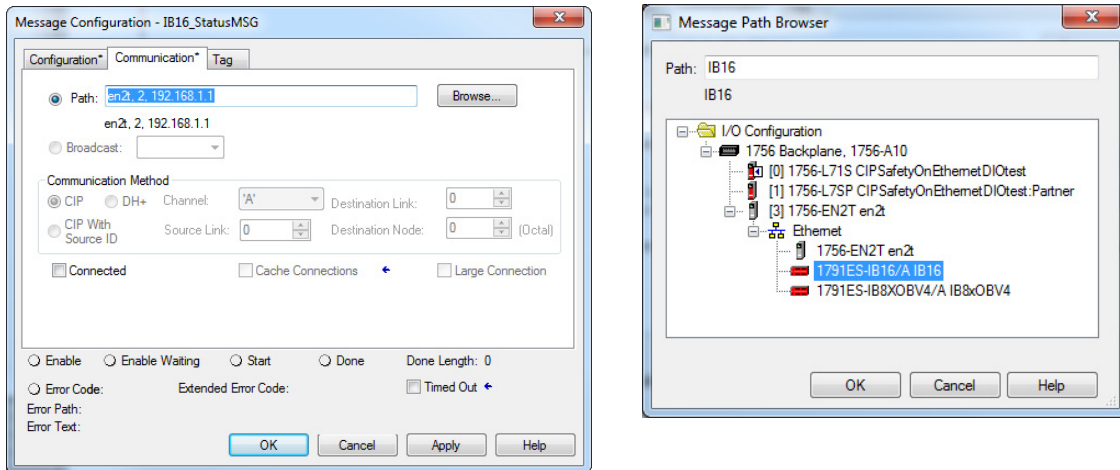
(1) This data is only diagnostic data. This data does not have safety integrity.

- From the top of the Message Configuration dialog box, choose the Communication tab.

This dialog box requires the path to the module.

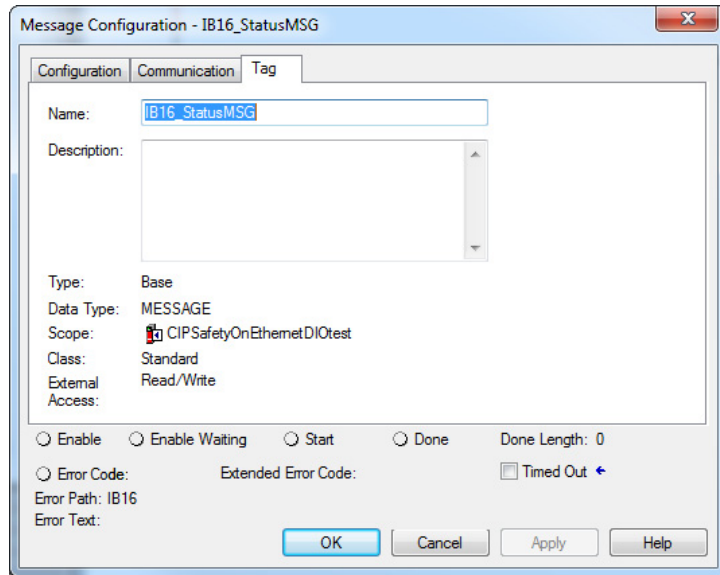
- Click Browse to go to the module that the MSG reads.

**Figure 41 - Instance 869 Communication Tab**



5. From the top of the Message Configuration dialog box, click Tag.

Figure 42 - Instance 869 Tag Tab



When the explicit message reads the data from the 1791ES-IB16 module, the data appears in the MSGdata tags as shown in [Figure 43](#).

Figure 43 - Instance 869 MSGdata Tags

+	IB16MSGdata[0]	-65536		Decimal	DINT	Standard
-	IB16MSGdata[1]	1048575		Decimal	DINT	Standard
	-IB16MSGdata[1].0	1		Decimal	BOOL	Standard
	-IB16MSGdata[1].1	1		Decimal	BOOL	Standard
	-IB16MSGdata[1].2	1		Decimal	BOOL	Standard
	-IB16MSGdata[1].3	1		Decimal	BOOL	Standard
	-IB16MSGdata[1].4	1		Decimal	BOOL	Standard
	-IB16MSGdata[1].5	1		Decimal	BOOL	Standard
	-IB16MSGdata[1].6	1		Decimal	BOOL	Standard
	-IB16MSGdata[1].7	1		Decimal	BOOL	Standard
	-IB16MSGdata[1].8	1		Decimal	BOOL	Standard
	-IB16MSGdata[1].9	1		Decimal	BOOL	Standard
	-IB16MSGdata[1].10	1		Decimal	BOOL	Standard
	-IB16MSGdata[1].11	1		Decimal	BOOL	Standard
	-IB16MSGdata[1].12	1		Decimal	BOOL	Standard
	-IB16MSGdata[1].13	1		Decimal	BOOL	Standard
	-IB16MSGdata[1].14	1		Decimal	BOOL	Standard
	-IB16MSGdata[1].15	1		Decimal	BOOL	Standard
	-IB16MSGdata[1].16	1		Decimal	BOOL	Standard
	-IB16MSGdata[1].17	1		Decimal	BOOL	Standard
	-IB16MSGdata[1].18	1		Decimal	BOOL	Standard
	-IB16MSGdata[1].19	1		Decimal	BOOL	Standard
	-IB16MSGdata[1].20	0		Decimal	BOOL	Standard
	-IB16MSGdata[1].21	0		Decimal	BOOL	Standard
	-IB16MSGdata[1].22	0		Decimal	BOOL	Standard
	-IB16MSGdata[1].23	0		Decimal	BOOL	Standard

The first 32 bits of the instance are in IB16MSGdata[0].0...31, and the final 24 bits are in IB16MSGdata[1].0...23. Map these 56 bits according to Instance 869. An easy method to do this mapping is to create a user-defined tag (UDT) for Instance 869. Once complete, it appears as shown in [Figure 44](#).

**Figure 44 - Instance 869 UDT**

Name: Instance\_869\_1791ESIB16 Data Type Size: 8 bytes

Description: UDT for Instance 869

Members:

Name	Data Type	Description
Reserved1	BOOL	Safety Input 0 / obtain from implicit Input Status
Reserved2	BOOL	Safety Input 1 / obtain from implicit Input Status
Reserved3	BOOL	Safety Input 2 / obtain from implicit Input Status
Reserved4	BOOL	Safety Input 3 / obtain from implicit Input Status
Reserved5	BOOL	Safety Input 4 / obtain from implicit Input Status
Reserved6	BOOL	Safety Input 5 / obtain from implicit Input Status
Reserved7	BOOL	Safety Input 6 / obtain from implicit Input Status
Reserved8	BOOL	Safety Input 7 / obtain from implicit Input Status
Reserved9	BOOL	Safety Input 8 / obtain from implicit Input Status
Reserved10	BOOL	Safety Input 9 / obtain from implicit Input Status
Reserved11	BOOL	Safety Input 10 / obtain from implicit Input Status
Reserved12	BOOL	Safety Input 11 / obtain from implicit Input Status
Reserved13	BOOL	Safety Input 12 / obtain from implicit Input Status
Reserved14	BOOL	Safety Input 13 / obtain from implicit Input Status
Reserved15	BOOL	Safety Input 14 / obtain from implicit Input Status
Reserved16	BOOL	Safety Input 15 / obtain from implicit Input Status
Safety_Input_0_Status	BOOL	1=GOOD 0=FAULT
Safety_Input_1_Status	BOOL	1=GOOD 0=FAULT
Safety_Input_2_Status	BOOL	1=GOOD 0=FAULT
Safety_Input_3_Status	BOOL	1=GOOD 0=FAULT
Safety_Input_4_Status	BOOL	1=GOOD 0=FAULT
Safety_Input_5_Status	BOOL	1=GOOD 0=FAULT
Safety_Input_6_Status	BOOL	1=GOOD 0=FAULT
Safety_Input_7_Status	BOOL	1=GOOD 0=FAULT
Safety_Input_8_Status	BOOL	1=GOOD 0=FAULT
Safety_Input_9_Status	BOOL	1=GOOD 0=FAULT

Properties: Extended Properties...  
**General**  
 Data Type: BOOL  
 Description: 1=GOOD 0=FA...  
 External Access: Read/Write  
 Name: Safety\_Input\_16\_S  
 Style: Decimal

Buttons: OK, Cancel, Apply, Help

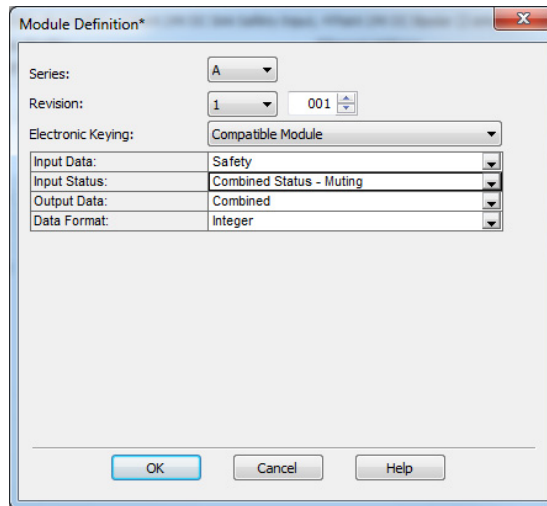
## Get Status Messages from 1732ES Modules

Follow these steps to get status messages from 1732ES modules.

**TIP** The process is identical for all 1732ES modules.

### 1732ES-IB12XOB4 Modules

1. In the Module Definition dialog box, from the Input Status pull-down menu, choose Combined Status.



This selection creates a three-byte input assembly, as shown, for the 1732ES-IB12XOB4 modules.

IB12XOB4:I	{ ... }
-IB12XOB4:I.RunMode	0
-IB12XOB4:I.ConnectionFaulted	0
-IB12XOB4:I.Pt00Data	0
-IB12XOB4:I.Pt01Data	0
-IB12XOB4:I.Pt02Data	0
-IB12XOB4:I.Pt03Data	0
-IB12XOB4:I.Pt04Data	0
-IB12XOB4:I.Pt05Data	0
-IB12XOB4:I.Pt06Data	0
-IB12XOB4:I.Pt07Data	0
-IB12XOB4:I.Pt08Data	0
-IB12XOB4:I.Pt09Data	0
-IB12XOB4:I.Pt10Data	0
-IB12XOB4:I.Pt11Data	0
-IB12XOB4:I.Muting03Status	0
-IB12XOB4:I.Muting07Status	0
-IB12XOB4:I.Muting11Status	0
-IB12XOB4:I.OutputPowerStatus	0
-IB12XOB4:I.InputPowerStatus	0
-IB12XOB4:I.CombinedOutputStatus	0
-IB12XOB4:I.CombinedInputStatus	0

2. Use the CombinedInputStatus and CombinedOutputStatus bits to detect if one or more of the I/O points on the module have a fault.



- If any input or output status bits go to a value of 0 (0 = bad; 1 = good), use the CombinedInputStatus and CombinedOutputStatus bits to condition your MSG rungs as follows.

Only use of the CombinedInputStatus bit is shown. Create similar rungs by using the CombinedOutputStatus bit instead of the CombinedInputStatus bit.

- The second rung can be used to read the status on mode transition and once a fault is detected, continue reading until the fault is corrected.
- Place these rungs in the standard task.

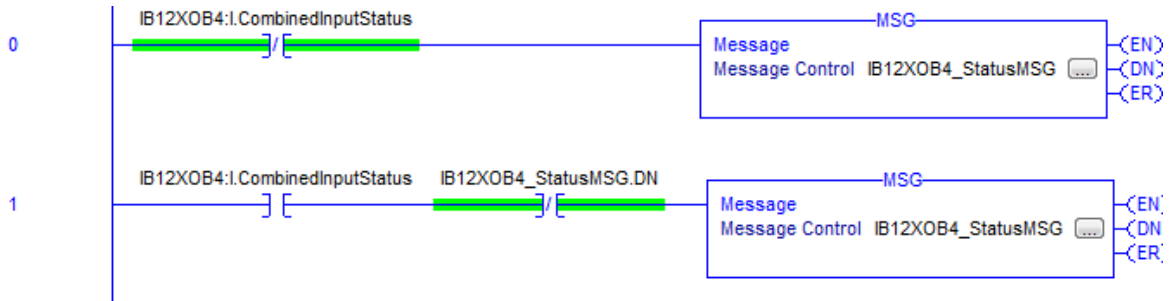
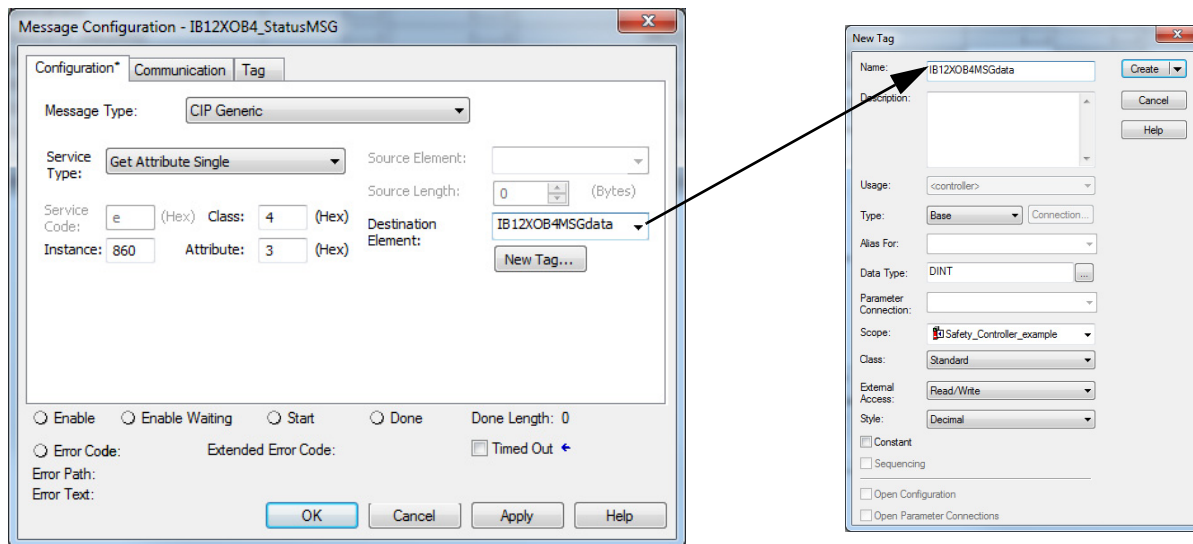


Figure 45...Figure 49 show the MSG instruction parameters to read Instance 860 from the 1732ES-IB12XOB4 module. See Appendix C of this manual for a layout of possible instances.

**Figure 45 - Instance 860 Configuration Tab**



Instance 860 (35C hex) is 5 bytes in length, so the destination tag IB12XOB4MSGdata must be at least 5 bytes in length to hold this data. The size is DINT[2] or 8 bytes (see [Table 36](#)).

**Table 36 - Layout of Instance 860 (35C hex) – 1732ES-IB12XOB4 Modules**

Instance Hex (decimal)	Connection Type	Byte	Bit 7	Bit 6	Bit 5	Bit 4	Bit 3	Bit 2	Bit 1	Bit 0
35C (860)	Safety and standard	0	Safety Input 7	Safety Input 6	Safety Input 5	Safety Input 4	Safety Input 3	Safety Input 2	Safety Input 1	Safety Input 0
		1	Safety Input 3 Status	Safety Input 2 Status	Safety Input 1 Status	Safety Input 0 Status	Safety Input 11	Safety Input 10	Safety Input 9	Safety Input 8
		2	Safety Input 11 Status	Safety Input 10 Status	Safety Input 9 Status	Safety Input 8 Status	Safety Input 7 Status	Safety Input 6 Status	Safety Input 5 Status	Safety Input 4 Status
		3	Safety Output 3 Monitor	Safety Output 2 Monitor	Safety Output 1 Monitor	Safety Output 0 Monitor	Safety Output 3 Status	Safety Output 2 Status	Safety Output 1 Status	Safety Output 0 Status
		4	Reserved	Reserved	Input Power Error <sup>(1)</sup>	Output Power Error <sup>(1)</sup>	Reserved	Muting Lamp 11 Status	Muting Lamp 7 Status	Muting Lamp 3 Status

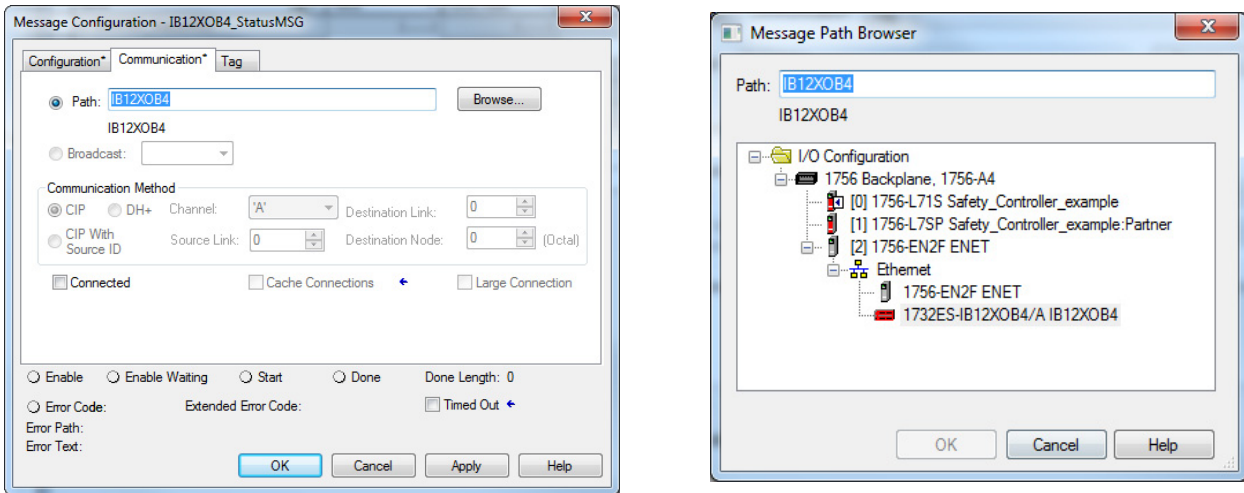
(1) This data is only diagnostic data. This data does not have safety integrity.

- From the top of the Message Configuration dialog box, choose the Communication tab.

This dialog box requires the path to the module.

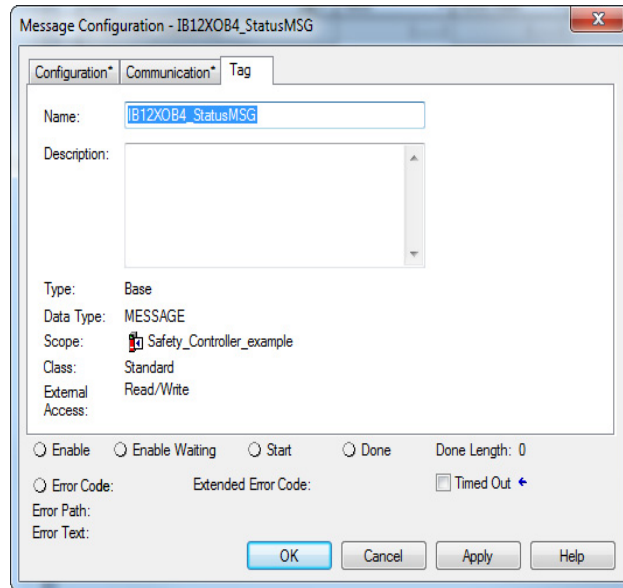
- Click Browse to go to the module that the MSG reads.

**Figure 46 - Instance 860 Communication Tab**



5. From the top of the Message Configuration dialog box, click Tag.

**Figure 47 - Instance 860 Tag Tab**



When the explicit message reads the data from the 1732ES-IB12XOB4 modules, the data appears in the MSGdata tags as shown in [Figure 48](#).

**Figure 48 - Instance 860 MSGdata Tags**

[-] IB12XOB4MSGdata	0	Decimal	DINT	Standard
[-] IB12XOB4MSGdata.0	0	Decimal	BOOL	Standard
[-] IB12XOB4MSGdata.1	0	Decimal	BOOL	Standard
[-] IB12XOB4MSGdata.2	0	Decimal	BOOL	Standard
[-] IB12XOB4MSGdata.3	0	Decimal	BOOL	Standard
[-] IB12XOB4MSGdata.4	0	Decimal	BOOL	Standard
[-] IB12XOB4MSGdata.5	0	Decimal	BOOL	Standard
[-] IB12XOB4MSGdata.6	0	Decimal	BOOL	Standard
[-] IB12XOB4MSGdata.7	0	Decimal	BOOL	Standard
[-] IB12XOB4MSGdata.8	0	Decimal	BOOL	Standard
[-] IB12XOB4MSGdata.9	0	Decimal	BOOL	Standard
[-] IB12XOB4MSGdata.10	0	Decimal	BOOL	Standard
[-] IB12XOB4MSGdata.11	0	Decimal	BOOL	Standard
[-] IB12XOB4MSGdata.12	0	Decimal	BOOL	Standard
[-] IB12XOB4MSGdata.13	0	Decimal	BOOL	Standard
[-] IB12XOB4MSGdata.14	0	Decimal	BOOL	Standard
[-] IB12XOB4MSGdata.15	0	Decimal	BOOL	Standard
[-] IB12XOB4MSGdata.16	0	Decimal	BOOL	Standard
[-] IB12XOB4MSGdata.17	0	Decimal	BOOL	Standard
[-] IB12XOB4MSGdata.18	0	Decimal	BOOL	Standard
[-] IB12XOB4MSGdata.19	0	Decimal	BOOL	Standard
[-] IB12XOB4MSGdata.20	0	Decimal	BOOL	Standard
[-] IB12XOB4MSGdata.21	0	Decimal	BOOL	Standard
[-] IB12XOB4MSGdata.22	0	Decimal	BOOL	Standard
[-] IB12XOB4MSGdata.23	0	Decimal	BOOL	Standard
[-] IB12XOB4MSGdata.24	0	Decimal	BOOL	Standard
[-] IB12XOB4MSGdata.25	0	Decimal	BOOL	Standard

The first 32 bits of the instance are in IB12XOB4MSGdata[0].0...31, and the final 8 bits are in IB12XOB4MSGdata[1].0...7. Map these 40 bits according to Instance 860. An easy method to do this mapping is to create a user-defined tag (UDT) for Instance 860. Once complete, it appears as shown in [Figure 49](#).

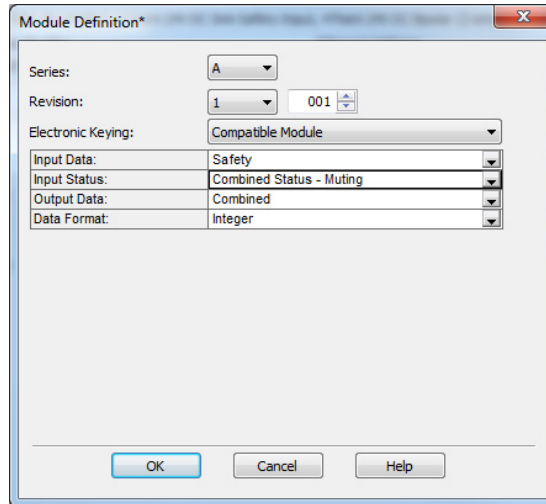
Figure 49 - Instance 860 UDT

The screenshot displays the configuration for a User-Defined Tag (UDT) named 'Instance\_860\_1732ESIB12XOBV2'. The data type size is set to 8 bytes. The description is 'UDT for Instance 860'. The members list includes 16 reserved boolean variables and 10 safety input status variables, all of type BOOL.

Name	Data Type	Description
Reserved1	BOOL	Safety Input 0 / obtain from implicit Input Status
Reserved2	BOOL	Safety Input 1 / obtain from implicit Input Status
Reserved3	BOOL	Safety Input 2 / obtain from implicit Input Status
Reserved4	BOOL	Safety Input 3 / obtain from implicit Input Status
Reserved5	BOOL	Safety Input 4 / obtain from implicit Input Status
Reserved6	BOOL	Safety Input 5 / obtain from implicit Input Status
Reserved7	BOOL	Safety Input 6 / obtain from implicit Input Status
Reserved8	BOOL	Safety Input 7 / obtain from implicit Input Status
Reserved9	BOOL	Safety Input 8 / obtain from implicit Input Status
Reserved10	BOOL	Safety Input 9 / obtain from implicit Input Status
Reserved11	BOOL	Safety Input 10 / obtain from implicit Input Status
Reserved12	BOOL	Safety Input 11 / obtain from implicit Input Status
Reserved13	BOOL	Safety Input 12 / obtain from implicit Input Status
Reserved14	BOOL	Safety Input 13 / obtain from implicit Input Status
Reserved15	BOOL	Safety Input 14 / obtain from implicit Input Status
Reserved16	BOOL	Safety Input 15 / obtain from implicit Input Status
Safety_Input_0_Status	BOOL	1=GOOD 0=FAULT
Safety_Input_1_Status	BOOL	1=GOOD 0=FAULT
Safety_Input_2_Status	BOOL	1=GOOD 0=FAULT
Safety_Input_3_Status	BOOL	1=GOOD 0=FAULT
Safety_Input_4_Status	BOOL	1=GOOD 0=FAULT
Safety_Input_5_Status	BOOL	1=GOOD 0=FAULT
Safety_Input_6_Status	BOOL	1=GOOD 0=FAULT
Safety_Input_7_Status	BOOL	1=GOOD 0=FAULT
Safety_Input_8_Status	BOOL	1=GOOD 0=FAULT
Safety_Input_9_Status	BOOL	1=GOOD 0=FAULT

## 1732ES-IB12XOBV2 Modules

1. In the Module Definition dialog box, from the Input Status pull-down menu, choose Combined Status.



This selection creates a three-byte input assembly, as shown, for the 1732ES-IB12XOBV2 modules.

[-] IB12XOBV2:1	{...}
IB12XOBV2:1.RunMode	0
IB12XOBV2:1.ConnectionFaulted	0
IB12XOBV2:1.Pt00Data	0
IB12XOBV2:1.Pt01Data	0
IB12XOBV2:1.Pt02Data	0
IB12XOBV2:1.Pt03Data	0
IB12XOBV2:1.Pt04Data	0
IB12XOBV2:1.Pt05Data	0
IB12XOBV2:1.Pt06Data	0
IB12XOBV2:1.Pt07Data	0
IB12XOBV2:1.Pt08Data	0
IB12XOBV2:1.Pt09Data	0
IB12XOBV2:1.Pt10Data	0
IB12XOBV2:1.Pt11Data	0
IB12XOBV2:1.Muting03Status	0
IB12XOBV2:1.Muting07Status	0
IB12XOBV2:1.Muting11Status	0
IB12XOBV2:1.OutputPowerStatus	0
IB12XOBV2:1.InputPowerStatus	0
IB12XOBV2:1.CombinedOutputStatus	0
IB12XOBV2:1.CombinedInputStatus	0

2. Use the CombinedInputStatus and CombinedOutputStatus bits to detect if one or more of the I/O points on the module have a fault.
  - If any input or output status bits go to a value of 0 (0 = bad; 1 = good), use the CombinedInputStatus and CombinedOutputStatus bits to condition your MSG rungs as follows.

Only use of the CombinedInputStatus bit is shown. Create similar rungs by using the CombinedOutputStatus bit instead of the CombinedInputStatus bit.

- The second rung can be used to read the status on mode transition and once a fault is detected, continue reading until the fault is corrected.
- Place these rungs in the standard task.

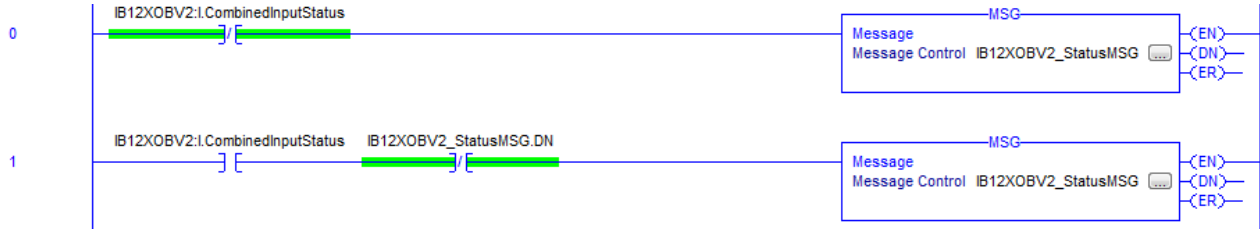
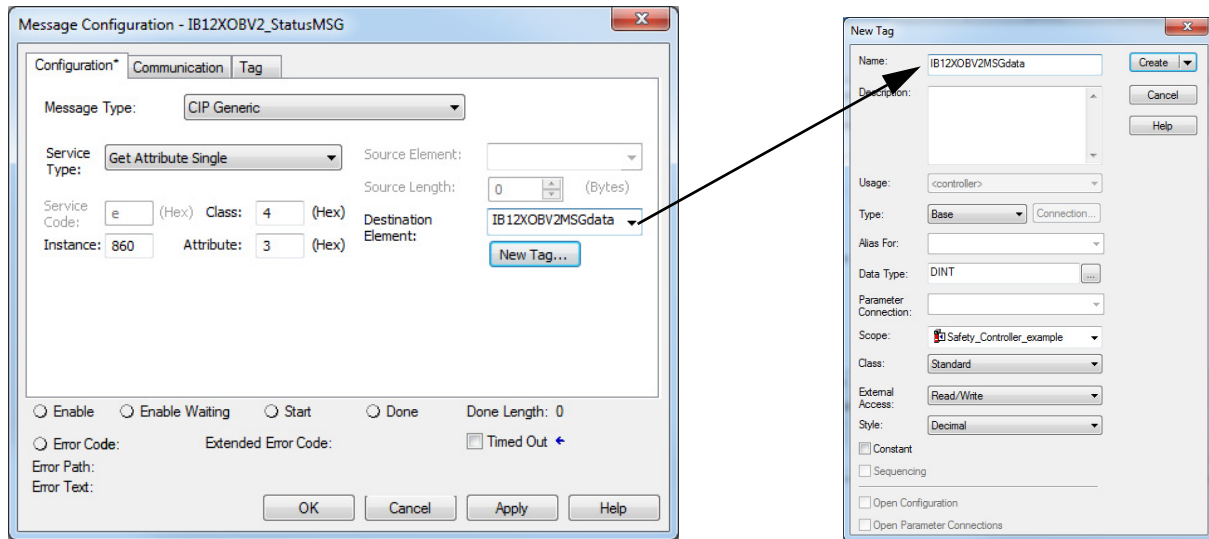


Figure 50...Figure 54 show the MSG instruction parameters to read Instance 860 from the 1732ES-IB12XOBV2 module. See Appendix C of this manual for a layout of possible instances.

Figure 50 - Instance 860 Configuration Tab



Instance 860 (35C hex) is 5 bytes in length, so the destination tag IB12XOBV2MSGdata must be at least 5 bytes in length to hold this data. The size is DINT[2] or 8 bytes (see [Table 37](#)).

**Table 37 - Layout of Instance 860 (35C hex) – 1732ES-IB12XOBV2 Modules**

Instance Hex (decimal)	Connection Type	Byte	Bit 7	Bit 6	Bit 5	Bit 4	Bit 3	Bit 2	Bit 1	Bit 0
35C (860)	Safety and standard	0	Safety Input 7	Safety Input 6	Safety Input 5	Safety Input 4	Safety Input 3	Safety Input 2	Safety Input 1	Safety Input 0
		1	Safety Input 3 Status	Safety Input 2 Status	Safety Input 1 Status	Safety Input 0 Status	Safety Input 11	Safety Input 10	Safety Input 9	Safety Input 8
		2	Safety Input 11 Status	Safety Input 10 Status	Safety Input 9 Status	Safety Input 8 Status	Safety Input 7 Status	Safety Input 6 Status	Safety Input 5 Status	Safety Input 4 Status
		3	Safety Output 3 Monitor	Safety Output 2 Monitor	Safety Output 1 Monitor	Safety Output 0 Monitor	Safety Output 3 Status	Safety Output 2 Status	Safety Output 1 Status	Safety Output 0 Status
		4	Reserved	Reserved	Input Power Error <sup>(1)</sup>	Output Power Error <sup>(1)</sup>	Reserved	Muting Lamp 11	Muting Lamp 7	Muting Lamp 3

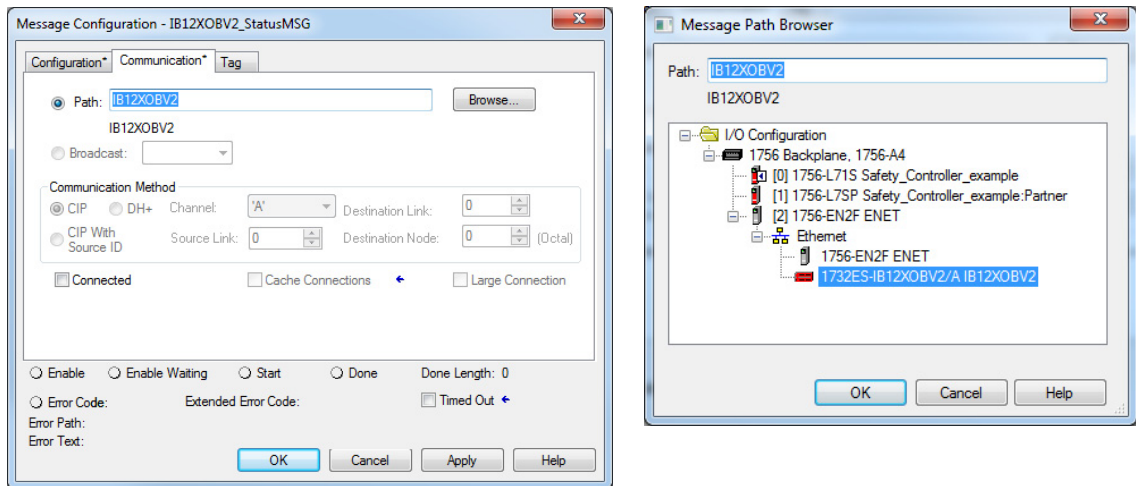
(1) This data is only diagnostic data. This data does not have safety integrity.

- From the top of the Message Configuration dialog box, choose the Communication tab.

This dialog box requires the path to the module.

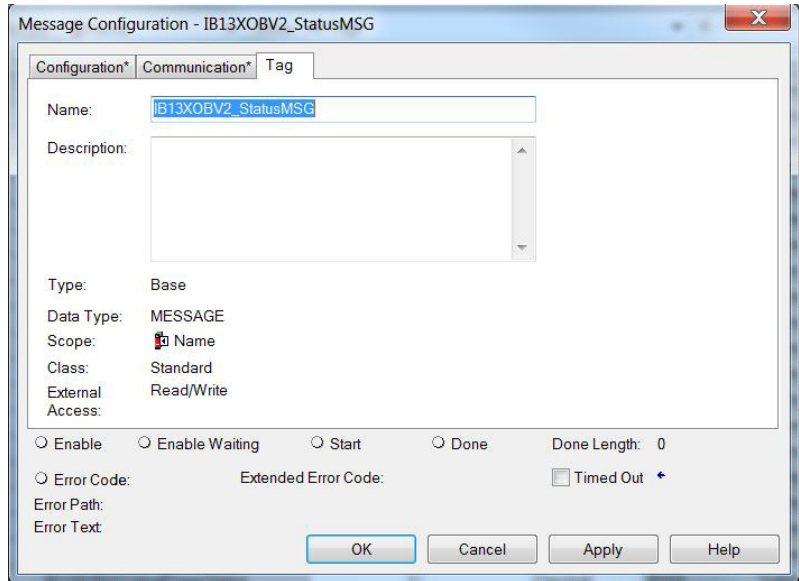
- Click Browse to go to the module that the MSG reads.

**Figure 51 - Instance 860 Communication Tab**



5. From the top of the Message Configuration dialog box, click Tag.

**Figure 52 - Instance 860 Tag Tab**



When the explicit message reads the data from the 1732ESIB12XOBV2 modules, the data appears in the MSGdata tags as shown in [Figure 53](#).

**Figure 53 - Instance 860 MSGdata Tags**

IB12XOBV2MSGdata	0		Decimal	DINT	Standard
IB12XOBV2MSGdata.0	0		Decimal	BOOL	Standard
IB12XOBV2MSGdata.1	0		Decimal	BOOL	Standard
IB12XOBV2MSGdata.2	0		Decimal	BOOL	Standard
IB12XOBV2MSGdata.3	0		Decimal	BOOL	Standard
IB12XOBV2MSGdata.4	0		Decimal	BOOL	Standard
IB12XOBV2MSGdata.5	0		Decimal	BOOL	Standard
IB12XOBV2MSGdata.6	0		Decimal	BOOL	Standard
IB12XOBV2MSGdata.7	0		Decimal	BOOL	Standard
IB12XOBV2MSGdata.8	0		Decimal	BOOL	Standard
IB12XOBV2MSGdata.9	0		Decimal	BOOL	Standard
IB12XOBV2MSGdata.10	0		Decimal	BOOL	Standard
IB12XOBV2MSGdata.11	0		Decimal	BOOL	Standard
IB12XOBV2MSGdata.12	0		Decimal	BOOL	Standard
IB12XOBV2MSGdata.13	0		Decimal	BOOL	Standard
IB12XOBV2MSGdata.14	0		Decimal	BOOL	Standard
IB12XOBV2MSGdata.15	0		Decimal	BOOL	Standard
IB12XOBV2MSGdata.16	0		Decimal	BOOL	Standard
IB12XOBV2MSGdata.17	0		Decimal	BOOL	Standard
IB12XOBV2MSGdata.18	0		Decimal	BOOL	Standard
IB12XOBV2MSGdata.19	0		Decimal	BOOL	Standard
IB12XOBV2MSGdata.20	0		Decimal	BOOL	Standard
IB12XOBV2MSGdata.21	0		Decimal	BOOL	Standard
IB12XOBV2MSGdata.22	0		Decimal	BOOL	Standard
IB12XOBV2MSGdata.23	0		Decimal	BOOL	Standard
IB12XOBV2MSGdata.24	0		Decimal	BOOL	Standard
IB12XOBV2MSGdata.25	0		Decimal	BOOL	Standard
IB12XOBV2MSGdata.26	0		Decimal	BOOL	Standard



The first 32 bits of the instance are in IB12XOBV2MSGdata[0].0...31, and the final 8 bits are in IB12XOBV2MSGdata[1].0...7. Map these 40 bits according to Instance 860. An easy method to do this mapping is to create a user-defined tag (UDT) for Instance 860. Once complete, it appears as shown in [Figure 54](#).

**Figure 54 - Instance 860 UDT**

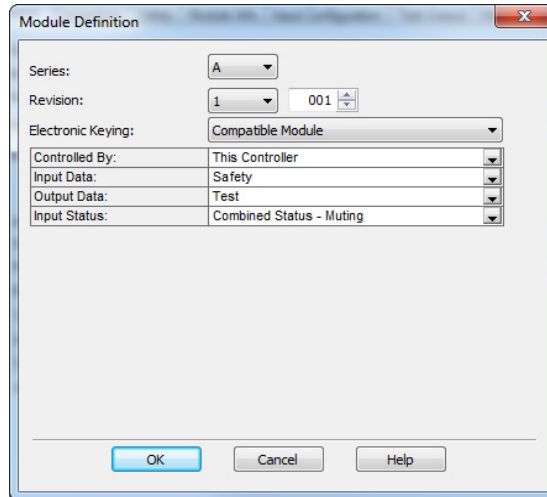
The screenshot displays the configuration for a User-Defined Tag (UDT) for Instance 860. The dialog box includes the following fields and components:

- Name:** Instance\_860\_1732ESIB12XOBV2
- Data Type Size:** 8 bytes
- Description:** UDT for Instance 860
- Members:** A table listing 16 reserved members and 10 safety input status members.
- Properties Panel:** Shows the General tab with the following details:
  - Data Type Size: 8 bytes
  - Description: UDT for Instance 860
  - Name: Instance\_860\_1732ESIB12XOBV2

Name	Data Type	Description
Reserved1	BOOL	Safety Input 0 / obtain from implicit Input Status
Reserved2	BOOL	Safety Input 1 / obtain from implicit Input Status
Reserved3	BOOL	Safety Input 2 / obtain from implicit Input Status
Reserved4	BOOL	Safety Input 3 / obtain from implicit Input Status
Reserved5	BOOL	Safety Input 4 / obtain from implicit Input Status
Reserved6	BOOL	Safety Input 5 / obtain from implicit Input Status
Reserved7	BOOL	Safety Input 6 / obtain from implicit Input Status
Reserved8	BOOL	Safety Input 7 / obtain from implicit Input Status
Reserved9	BOOL	Safety Input 8 / obtain from implicit Input Status
Reserved10	BOOL	Safety Input 9 / obtain from implicit Input Status
Reserved11	BOOL	Safety Input 10 / obtain from implicit Input Status
Reserved12	BOOL	Safety Input 11 / obtain from implicit Input Status
Reserved13	BOOL	Safety Input 12 / obtain from implicit Input Status
Reserved14	BOOL	Safety Input 13 / obtain from implicit Input Status
Reserved15	BOOL	Safety Input 14 / obtain from implicit Input Status
Reserved16	BOOL	Safety Input 15 / obtain from implicit Input Status
Safety_Input_0_Status	BOOL	1=GOOD 0=FAULT
Safety_Input_1_Status	BOOL	1=GOOD 0=FAULT
Safety_Input_2_Status	BOOL	1=GOOD 0=FAULT
Safety_Input_3_Status	BOOL	1=GOOD 0=FAULT
Safety_Input_4_Status	BOOL	1=GOOD 0=FAULT
Safety_Input_5_Status	BOOL	1=GOOD 0=FAULT
Safety_Input_6_Status	BOOL	1=GOOD 0=FAULT
Safety_Input_7_Status	BOOL	1=GOOD 0=FAULT
Safety_Input_8_Status	BOOL	1=GOOD 0=FAULT
Safety_Input_9_Status	BOOL	1=GOOD 0=FAULT

## 1732ES-IB16 Modules

1. In the Module Definition dialog box, from the Input Status pull-down menu, choose Combined Status.



This selection creates a three-byte input assembly, as shown here.

IB16:I	
IB16:I.RunMode	
IB16:I.ConnectionFaulted	
IB16:I.Pt00Data	
IB16:I.Pt01Data	
IB16:I.Pt02Data	
IB16:I.Pt03Data	
IB16:I.Pt04Data	
IB16:I.Pt05Data	
IB16:I.Pt06Data	
IB16:I.Pt07Data	
IB16:I.Pt08Data	
IB16:I.Pt09Data	
IB16:I.Pt10Data	
IB16:I.Pt11Data	
IB16:I.Pt12Data	
IB16:I.Pt13Data	
IB16:I.Pt14Data	
IB16:I.Pt15Data	
IB16:I.Muting03Status	
IB16:I.Muting07Status	
IB16:I.Muting11Status	
IB16:I.Muting15Status	
IB16:I.InputPowerStatus	
IB16:I.CombinedInputStatus	

2. Use the CombinedInputStatus and CombinedOutputStatus bits to detect if one or more of the I/O points on the module have a fault.
  - If any input or output status bits go to a value of 0 (0 = bad; 1 = good), use the CombinedInputStatus and CombinedOutputStatus bits to condition your MSG rungs as follows.
 

Only use of the CombinedInputStatus bit is shown. Create similar rungs by using the CombinedOutputStatus bit instead of the CombinedInputStatus bit.

- The second rung can be used to read the status on mode transition and once a fault is detected, continue reading until the fault is corrected.
- Place these rungs in the standard task.

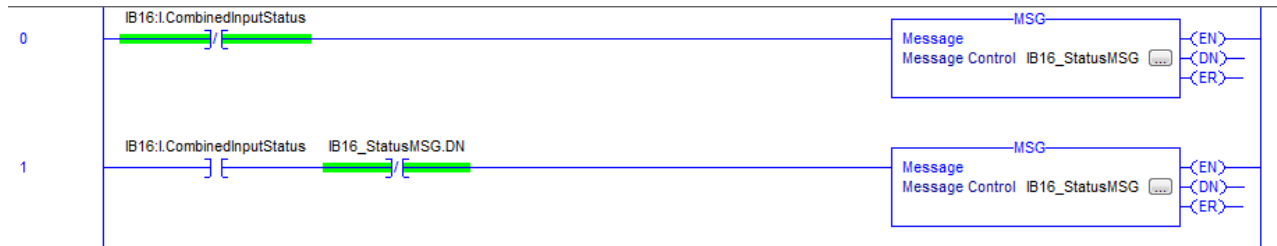
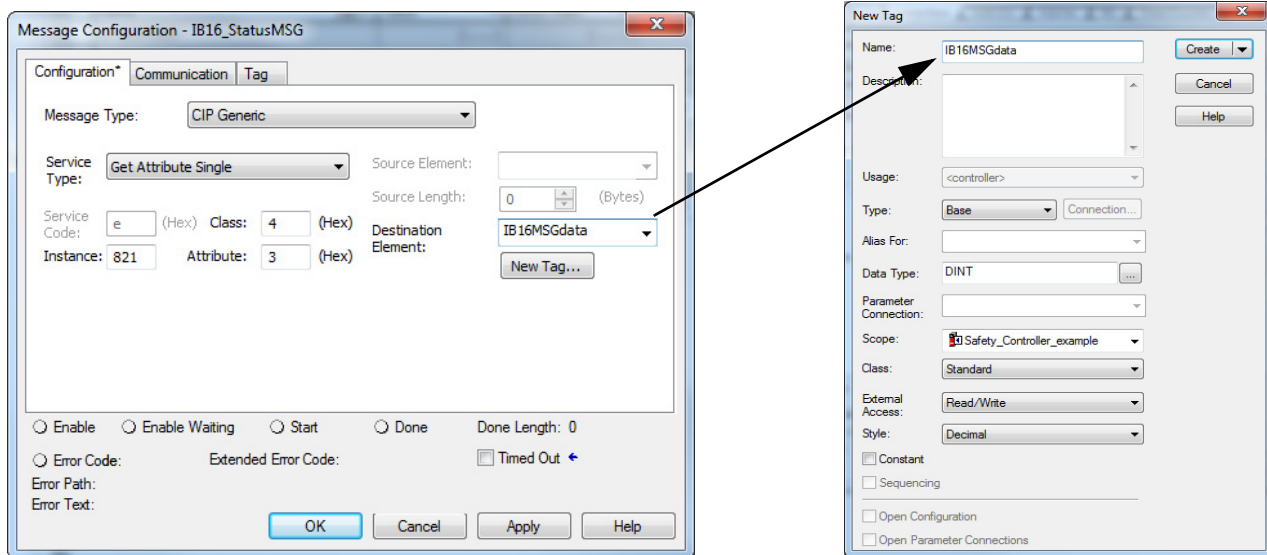


Figure 55...Figure 60 show the MSG instruction parameters to read Instance 821 from the 1732ES-IB16 module. See Appendix C of this manual for a layout of possible instances.

**Figure 55 - Instance 821 Configuration Tab**



Instance 821 (335 hex) is 5 bytes in length, so the destination tag IB16MSGdata must be at least 5 bytes in length to hold this data. The size is DINT[2] or 8 bytes (see [Table 38](#)).

**Table 38 - Layout of Instance 821 (335 hex) – 1732ES-IB16 Modules**

Instance Hex (decimal)	Connection Type	Byte	Bit 7	Figure56- Bit 6	Bit 5	Bit 4	Bit 3	Bit 2	Bit 1	Bit 0
335 (821)	Safety and standard	0	Safety Input 7	Safety Input 6	Safety Input 5	Safety Input 4	Safety Input 3	Safety Input 2	Safety Input 1	Safety Input 0
		1	Safety Input 15	Safety Input 14	Safety Input 13	Safety Input 12	Safety Input 11	Safety Input 10	Safety Input 9	Safety Input 8
		2	Safety Input 7 Status	Safety Input 6 Status	Safety Input 5 Status	Safety Input 4 Status	Safety Input 3 Status	Safety Input 2 Status	Safety Input 1 Status	Safety Input 0 Status
		3	Safety Input 15 Status	Safety Input 14 Status	Safety Input 13 Status	Safety Input 12 Status	Safety Input 11 Status	Safety Input 10 Status	Safety Input 9 Status	Safety Input 8 Status
		4	Reserved	Reserved	Input Power Error <sup>(1)</sup>	Reserved	Muting Lamp 15 Status	Muting Lamp 11 Status	Muting Lamp 7 Status	Muting Lamp 3 Status

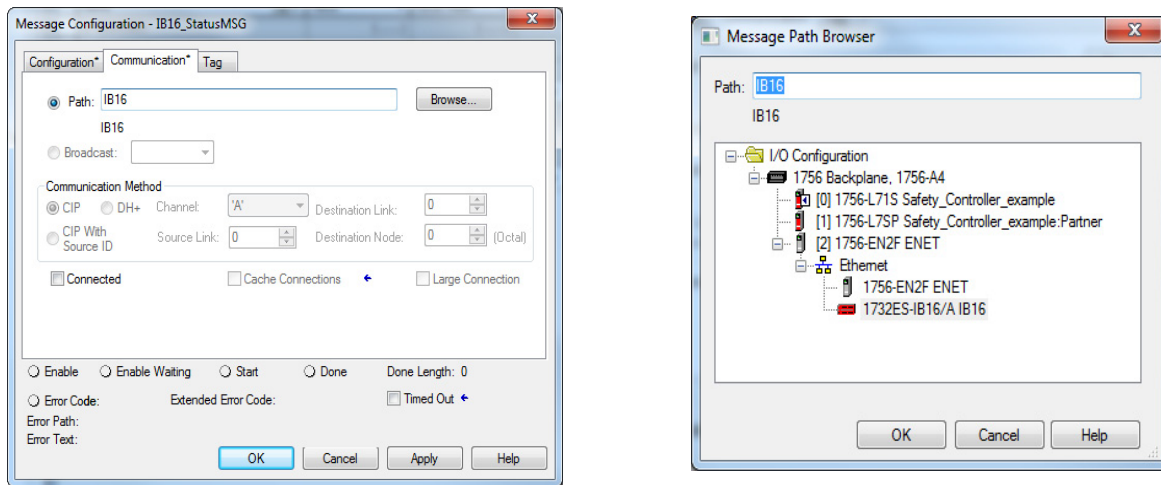
(1) This data is only diagnostic data. This data does not have safety integrity.

- From the top of the Message Configuration dialog box, choose the Communication tab.

This dialog box requires the path to the module.

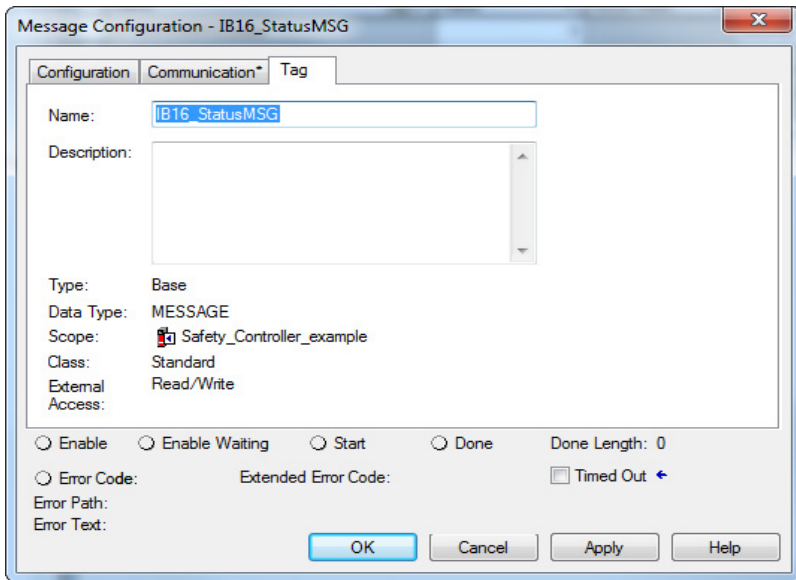
- Click Browse to go to the module that the MSG reads.

**Figure 57 - Instance 821 Communication Tab**



5. From the top of the Message Configuration dialog box, click Tag.

**Figure 58 - Instance 821 Tag Tab**



When the explicit message reads the data from the 1732ES-IB16 module, the data appears in the MSGdata tags as shown in [Figure 59](#).

**Figure 59 - Instance 821 MSGdata Tags**

[-] IB16MSGdata	0	Decimal	DINT	Standard
[-] IB16MSGdata.0	0	Decimal	BOOL	Standard
[-] IB16MSGdata.1	0	Decimal	BOOL	Standard
[-] IB16MSGdata.2	0	Decimal	BOOL	Standard
[-] IB16MSGdata.3	0	Decimal	BOOL	Standard
[-] IB16MSGdata.4	0	Decimal	BOOL	Standard
[-] IB16MSGdata.5	0	Decimal	BOOL	Standard
[-] IB16MSGdata.6	0	Decimal	BOOL	Standard
[-] IB16MSGdata.7	0	Decimal	BOOL	Standard
[-] IB16MSGdata.8	0	Decimal	BOOL	Standard
[-] IB16MSGdata.9	0	Decimal	BOOL	Standard
[-] IB16MSGdata.10	0	Decimal	BOOL	Standard
[-] IB16MSGdata.11	0	Decimal	BOOL	Standard
[-] IB16MSGdata.12	0	Decimal	BOOL	Standard
[-] IB16MSGdata.13	0	Decimal	BOOL	Standard
[-] IB16MSGdata.14	0	Decimal	BOOL	Standard
[-] IB16MSGdata.15	0	Decimal	BOOL	Standard
[-] IB16MSGdata.16	0	Decimal	BOOL	Standard
[-] IB16MSGdata.17	0	Decimal	BOOL	Standard
[-] IB16MSGdata.18	0	Decimal	BOOL	Standard
[-] IB16MSGdata.19	0	Decimal	BOOL	Standard
[-] IB16MSGdata.20	0	Decimal	BOOL	Standard
[-] IB16MSGdata.21	0	Decimal	BOOL	Standard
[-] IB16MSGdata.22	0	Decimal	BOOL	Standard
[-] IB16MSGdata.23	0	Decimal	BOOL	Standard
[-] IB16MSGdata.24	0	Decimal	BOOL	Standard
[-] IB16MSGdata.25	0	Decimal	BOOL	Standard

The first 32 bits of the instance are in IB16MSGdata[0].0...31, and the final 8 bits are in IB16MSGdata[1].0...7. Map these 40 bits according to Instance 821. An easy method to do this mapping is to create a user-defined tag (UDT) for Instance 821. Once complete, it appears as shown in [Figure 60](#).

Figure 60 - Instance 821 UDT

The screenshot displays the configuration for a User-Defined Tag (UDT). The main window has the following fields:

- Name:** Instance\_821\_1732ESIB16
- Data Type Size:** 8 bytes
- Description:** UDT for Instance 860

The **Members:** section contains a table with the following data:

Name	Data Type	Description
Reserved1	BOOL	Safety Input 0 / obtain from implicit Input Status
Reserved2	BOOL	Safety Input 1 / obtain from implicit Input Status
Reserved3	BOOL	Safety Input 2 / obtain from implicit Input Status
Reserved4	BOOL	Safety Input 3 / obtain from implicit Input Status
Reserved5	BOOL	Safety Input 4 / obtain from implicit Input Status
Reserved6	BOOL	Safety Input 5 / obtain from implicit Input Status
Reserved7	BOOL	Safety Input 6 / obtain from implicit Input Status
Reserved8	BOOL	Safety Input 7 / obtain from implicit Input Status
Reserved9	BOOL	Safety Input 8 / obtain from implicit Input Status
Reserved10	BOOL	Safety Input 9 / obtain from implicit Input Status
Reserved11	BOOL	Safety Input 10 / obtain from implicit Input Status
Reserved12	BOOL	Safety Input 11 / obtain from implicit Input Status
Reserved13	BOOL	Safety Input 12 / obtain from implicit Input Status
Reserved14	BOOL	Safety Input 13 / obtain from implicit Input Status
Reserved15	BOOL	Safety Input 14 / obtain from implicit Input Status
Reserved16	BOOL	Safety Input 15 / obtain from implicit Input Status
Safety_Input_0_Status	BOOL	1= GOOD 0= FAULT
Safety_Input_1_Status	BOOL	1= GOOD 0= FAULT
Safety_Input_2_Status	BOOL	1= GOOD 0= FAULT
Safety_Input_3_Status	BOOL	1= GOOD 0= FAULT
Safety_Input_4_Status	BOOL	1= GOOD 0= FAULT
Safety_Input_5_Status	BOOL	1= GOOD 0= FAULT
Safety_Input_6_Status	BOOL	1= GOOD 0= FAULT
Safety_Input_7_Status	BOOL	1= GOOD 0= FAULT
Safety_Input_8_Status	BOOL	1= GOOD 0= FAULT
Safety_Input_9_Status	BOOL	1= GOOD 0= FAULT

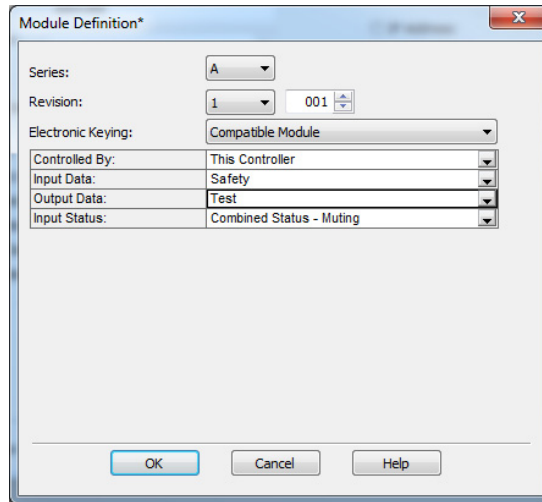
The right-hand **Properties** pane shows the following details:

- General**
  - Data Type Size: 8 bytes
  - Description: UDT for Instance...
  - Name: Instance\_821\_1732...

Buttons at the bottom include OK, Cancel, Apply, and Help.

## 1732ES-IBXOB8 Modules

1. In the Module Definition dialog box, from the Input Status pull-down menu, choose Combined Status.



This selection creates a three-byte input assembly, as shown here.

[-] IB8XOB8:I	
[-] IB8XOB8:I.RunMode	
[-] IB8XOB8:I.ConnectionFaulted	
[-] IB8XOB8:I.Pt00Data	
[-] IB8XOB8:I.Pt01Data	
[-] IB8XOB8:I.Pt02Data	
[-] IB8XOB8:I.Pt03Data	
[-] IB8XOB8:I.Pt04Data	
[-] IB8XOB8:I.Pt05Data	
[-] IB8XOB8:I.Pt06Data	
[-] IB8XOB8:I.Pt07Data	
[-] IB8XOB8:I.Muting03Status	
[-] IB8XOB8:I.Muting07Status	
[-] IB8XOB8:I.OutputPowerStatus	
[-] IB8XOB8:I.InputPowerStatus	
[-] IB8XOB8:I.CombinedOutputStatus	
[-] IB8XOB8:I.CombinedInputStatus	

2. Use the CombinedInputStatus and CombinedOutputStatus bits to detect if one or more of the I/O points on the module have a fault.
  - If any input or output status bits go to a value of 0 (0 = bad; 1 = good), use the CombinedInputStatus and CombinedOutputStatus bits to condition your MSG rungs as follows.
 

Only use of the CombinedInputStatus bit is shown. Create similar rungs by using the CombinedOutputStatus bit instead of the CombinedInputStatus bit.
  - The second rung can be used to read the status on mode transition and once a fault is detected, continue reading until the fault is corrected.

- Place these rungs in the standard task.

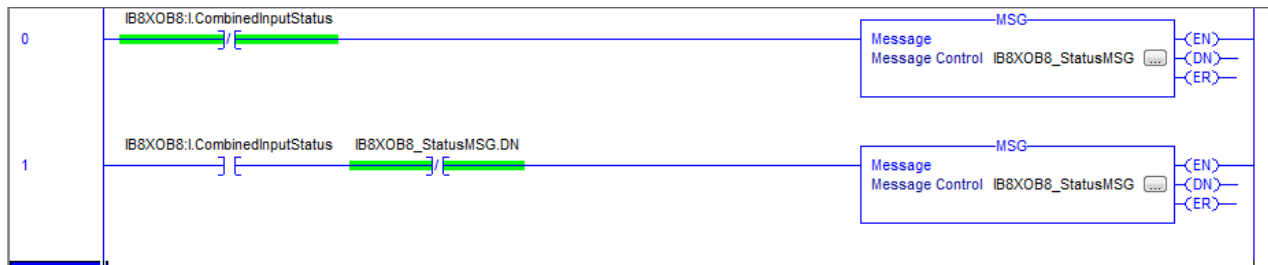
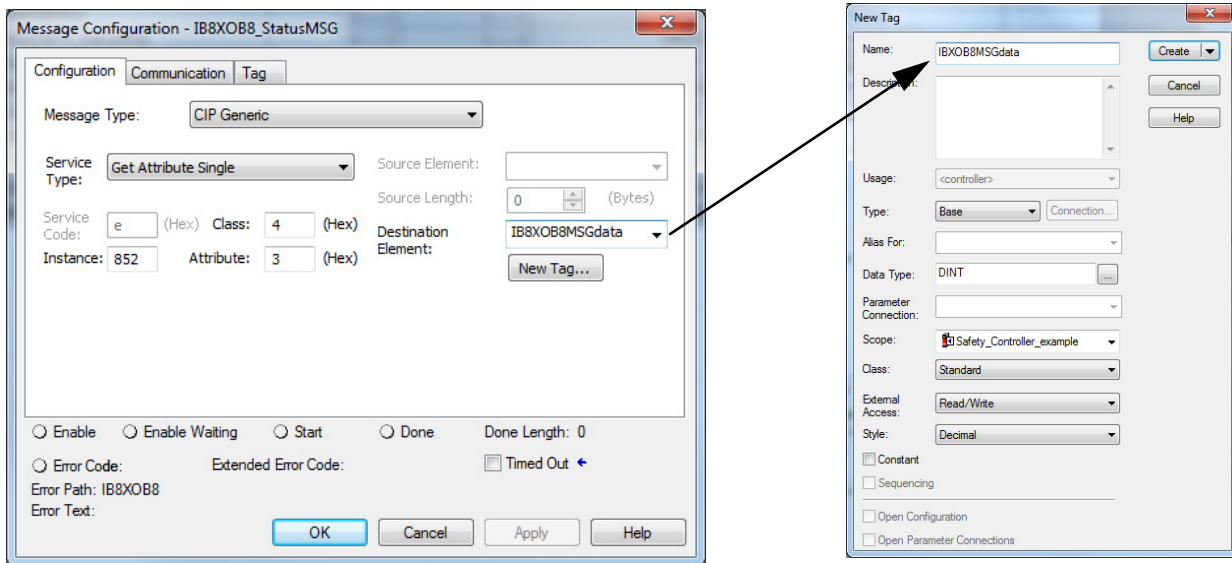


Figure 61...Figure 65 show the MSG instruction parameters to read Instance 852 from the 1732ES-IB8XOB8 module. See Appendix C of this manual for a layout of possible instances.

Figure 61 - Instance 852 Configuration Tab





Instance 852 (354 hex) is 5 bytes in length, so the destination tag IB8XOB8MSGdata must be at least 5 bytes in length to hold this data. The size is DINT[2] or 8 bytes (see [Table 39](#)).

**Table 39 - Layout of Instance 852 (354 hex) – 1732ES-IB8XOB8 Modules**

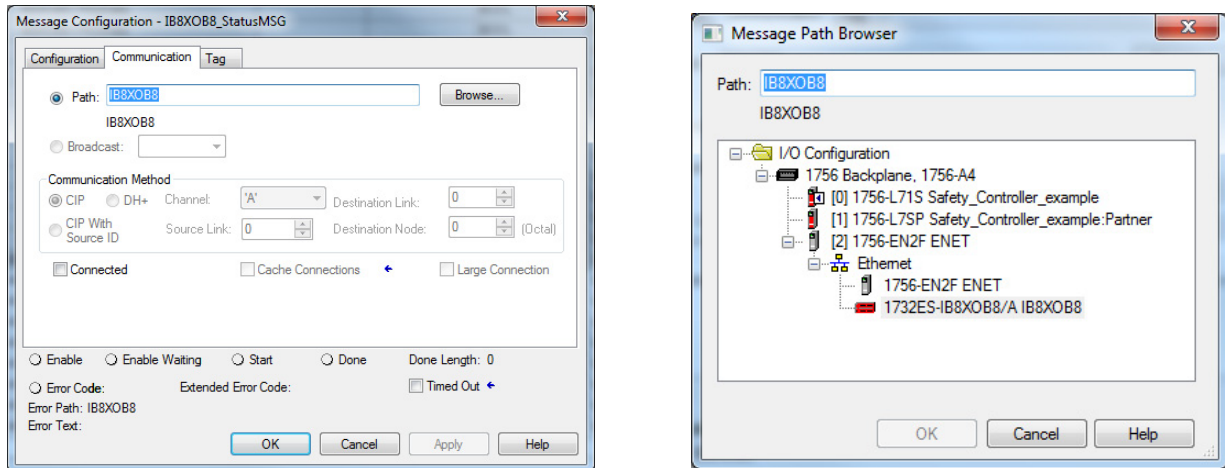
Instance Hex (decimal)	Connection Type	Byte	Bit 7	Bit 6	Bit 5	Bit 4	Bit 3	Bit 2	Bit 1	Bit 0
354 (852)	Safety and standard	0	Safety Input 7	Safety Input 6	Safety Input 5	Safety Input 4	Safety Input 3	Safety Input 2	Safety Input 1	Safety Input 0
		1	Safety Input 7 Status	Safety Input 6 Status	Safety Input 5 Status	Safety Input 4 Status	Safety Input 3 Status	Safety Input 2 Status	Safety Input 1 Status	Safety Input 0 Status
		2	Safety Output 7 Status	Safety Output 6 Status	Safety Output 5 Status	Safety Output 4 Status	Safety Output 3 Status	Safety Output 2 Status	Safety Output 1 Status	Safety Output 0 Status
		3	Safety Output 7 Monitor	Safety Output 6 Monitor	Safety Output 5 Monitor	Safety Output 4 Monitor	Safety Output 3 Monitor	Safety Output 2 Monitor	Safety Output 1 Monitor	Safety Output 0 Monitor
		4	Reserved	Reserved	Input Power Error <sup>(1)</sup>	Output Power Error <sup>(1)</sup>	Reserved	Reserved	Muting Lamp 7 Status	Muting Lamp 3 Status

- From the top of the Message Configuration dialog box, choose the Communication tab.

This dialog box requires the path to the module.

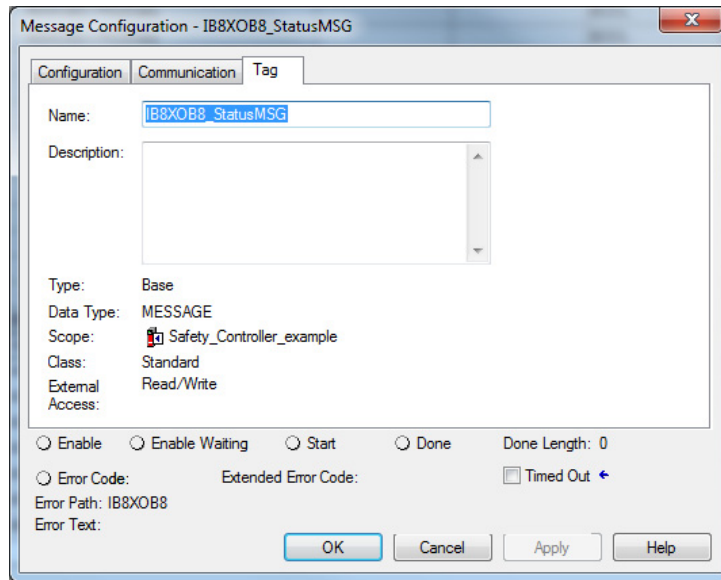
- Click Browse to go to the module that the MSG reads.

**Figure 62 - Instance 852 Communication Tab**



- From the top of the Message Configuration dialog box, click Tag to see this dialog box.

**Figure 63 - Instance 852 Tag Tab**



When the explicit message reads the data from the 1732ES-IB8XOB8 module, the data appears in the MSGdata tags as shown in [Figure 64](#).

**Figure 64 - Instance 852 MSGdata Tags**

IB8XOB8MSGdata	0	Decimal	DINT
IB8XOB8MSGdata.0	0	Decimal	BOOL
IB8XOB8MSGdata.1	0	Decimal	BOOL
IB8XOB8MSGdata.2	0	Decimal	BOOL
IB8XOB8MSGdata.3	0	Decimal	BOOL
IB8XOB8MSGdata.4	0	Decimal	BOOL
IB8XOB8MSGdata.5	0	Decimal	BOOL
IB8XOB8MSGdata.6	0	Decimal	BOOL
IB8XOB8MSGdata.7	0	Decimal	BOOL
IB8XOB8MSGdata.8	0	Decimal	BOOL
IB8XOB8MSGdata.9	0	Decimal	BOOL
IB8XOB8MSGdata.10	0	Decimal	BOOL
IB8XOB8MSGdata.11	0	Decimal	BOOL
IB8XOB8MSGdata.12	0	Decimal	BOOL
IB8XOB8MSGdata.13	0	Decimal	BOOL
IB8XOB8MSGdata.14	0	Decimal	BOOL
IB8XOB8MSGdata.15	0	Decimal	BOOL
IB8XOB8MSGdata.16	0	Decimal	BOOL
IB8XOB8MSGdata.17	0	Decimal	BOOL
IB8XOB8MSGdata.18	0	Decimal	BOOL
IB8XOB8MSGdata.19	0	Decimal	BOOL
IB8XOB8MSGdata.20	0	Decimal	BOOL
IB8XOB8MSGdata.21	0	Decimal	BOOL
IB8XOB8MSGdata.22	0	Decimal	BOOL
IB8XOB8MSGdata.23	0	Decimal	BOOL
IB8XOB8MSGdata.24	0	Decimal	BOOL
IB8XOB8MSGdata.25	0	Decimal	BOOL
IB8XOB8MSGdata.26	0	Decimal	BOOL
IB8XOB8MSGdata.27	0	Decimal	BOOL
IB8XOB8MSGdata.28	0	Decimal	BOOL
IB8XOB8MSGdata.29	0	Decimal	BOOL
IB8XOB8MSGdata.30	0	Decimal	BOOL
IB8XOB8MSGdata.31	0	Decimal	BOOL

The first 32 bits of the instance are in IB8XOB8MSGdata[0].0...31, and the final 8 bits are in IB8XOB8MSGdata[1].0...7. Map these 40 bits according to Instance 852. An easy method to do this mapping is to create a user-defined tag (UDT) for Instance 852. Once complete, it appears as shown in [Figure 65](#).

**Figure 65 - Instance 852 UDT**

**Name:** Instance\_852\_1732ESI8XOB8 **Data Type Size:** 8 bytes

**Description:** UDT for Instance 860

**Members:**

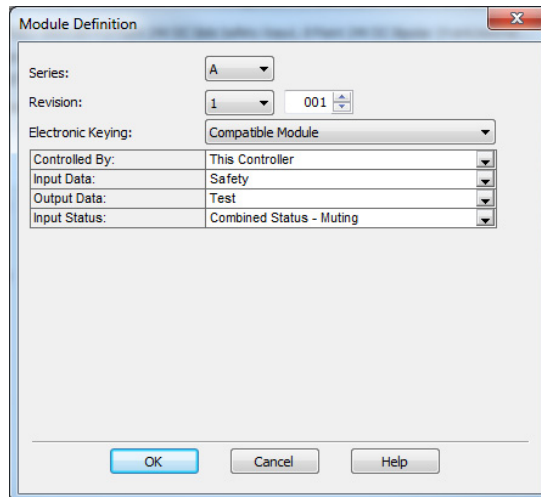
Name	Data Type	Description
Reserved1	BOOL	Safety Input 0 / obtain from implicit Input Status
Reserved2	BOOL	Safety Input 1 / obtain from implicit Input Status
Reserved3	BOOL	Safety Input 2 / obtain from implicit Input Status
Reserved4	BOOL	Safety Input 3 / obtain from implicit Input Status
Reserved5	BOOL	Safety Input 4 / obtain from implicit Input Status
Reserved6	BOOL	Safety Input 5 / obtain from implicit Input Status
Reserved7	BOOL	Safety Input 6 / obtain from implicit Input Status
Reserved8	BOOL	Safety Input 7 / obtain from implicit Input Status
Reserved9	BOOL	Safety Input 8 / obtain from implicit Input Status
Reserved10	BOOL	Safety Input 9 / obtain from implicit Input Status
Reserved11	BOOL	Safety Input 10 / obtain from implicit Input Status
Reserved12	BOOL	Safety Input 11 / obtain from implicit Input Status
Reserved13	BOOL	Safety Input 12 / obtain from implicit Input Status
Reserved14	BOOL	Safety Input 13 / obtain from implicit Input Status
Reserved15	BOOL	Safety Input 14 / obtain from implicit Input Status
Reserved16	BOOL	Safety Input 15 / obtain from implicit Input Status
Safety_Input_0_Status	BOOL	1=GOOD 0=FAULT
Safety_Input_1_Status	BOOL	1=GOOD 0=FAULT
Safety_Input_2_Status	BOOL	1=GOOD 0=FAULT
Safety_Input_3_Status	BOOL	1=GOOD 0=FAULT
Safety_Input_4_Status	BOOL	1=GOOD 0=FAULT
Safety_Input_5_Status	BOOL	1=GOOD 0=FAULT
Safety_Input_6_Status	BOOL	1=GOOD 0=FAULT
Safety_Input_7_Status	BOOL	1=GOOD 0=FAULT
Safety_Input_8_Status	BOOL	1=GOOD 0=FAULT
Safety_Input_9_Status	BOOL	1=GOOD 0=FAULT

**Properties Panel (General):**  
 Data Type Size: 8 bytes  
 Description: UDT for Instance 860  
 Name: Instance\_852\_1732

Buttons: OK, Cancel, Apply, Help

## 1732ES-IB8XOBV4 Modules

1. In the Module Definition dialog box, from the Input Status pull-down menu, choose Combined Status.



This selection creates a three-byte input assembly, as shown here.

[-] IB8XOBV4:1	
[-] IB8XOBV4:1.RunMode	
[-] IB8XOBV4:1.ConnectionFaulted	
[-] IB8XOBV4:1.Pt00Data	
[-] IB8XOBV4:1.Pt01Data	
[-] IB8XOBV4:1.Pt02Data	
[-] IB8XOBV4:1.Pt03Data	
[-] IB8XOBV4:1.Pt04Data	
[-] IB8XOBV4:1.Pt05Data	
[-] IB8XOBV4:1.Pt06Data	
[-] IB8XOBV4:1.Pt07Data	
[-] IB8XOBV4:1.Muting03Status	
[-] IB8XOBV4:1.Muting07Status	
[-] IB8XOBV4:1.OutputPowerStatus	
[-] IB8XOBV4:1.InputPowerStatus	
[-] IB8XOBV4:1.CombinedOutputStatus	
[-] IB8XOBV4:1.CombinedInputStatus	

2. Use the CombinedInputStatus and CombinedOutputStatus bits to detect if one or more of the I/O points on the module have a fault.
  - If any input or output status bits go to a value of 0 (0 = bad; 1 = good), use the CombinedInputStatus and CombinedOutputStatus bits to condition your MSG rungs as follows.
 

Only use of the CombinedInputStatus bit is shown. Create similar rungs by using the CombinedOutputStatus bit instead of the CombinedInputStatus bit.
  - The second rung can be used to read the status on mode transition and once a fault is detected, continue reading until the fault is corrected.

- Place these rungs in the standard task.

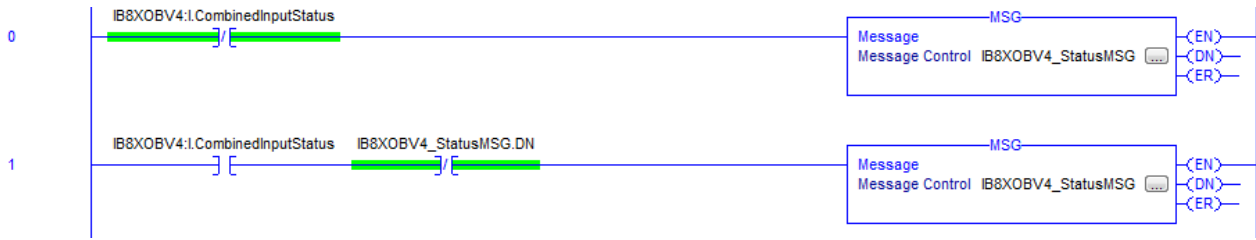
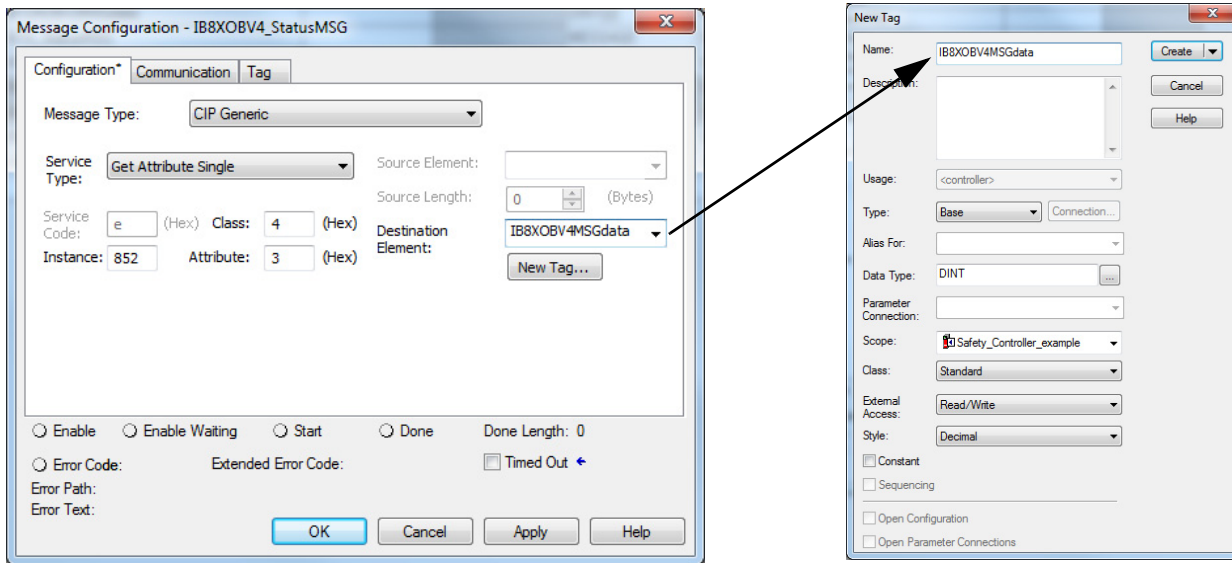


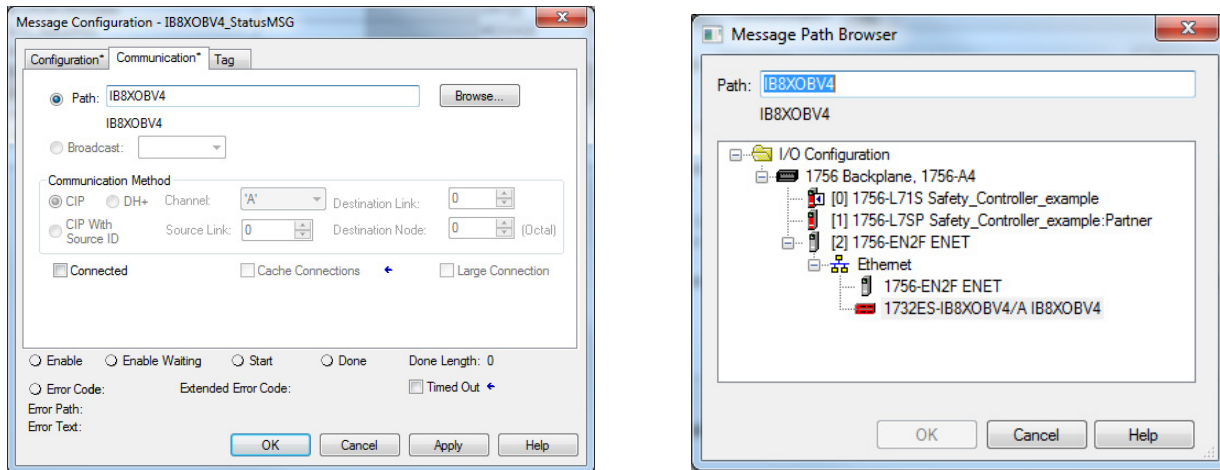
Figure 66...Figure 70 show the MSG instruction parameters to read Instance 852 from the 1732ES-IB8XOBV4 module. See Appendix C of this manual for a layout of possible instances.

**Figure 66 - Instance 852 Configuration Tab**



From the top of the Message Configuration dialog box, choose the Communication tab. This dialog box requires the path to the module. Click Browse to go to the module that the MSG reads.

Figure 67 - Instance 852 Communication Tab



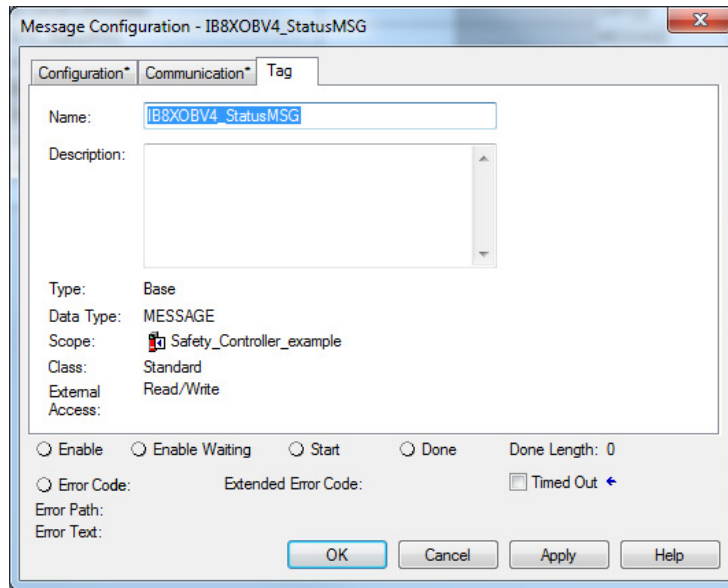
Instance 852 (354 hex) is 5 bytes in length, so the destination tag IB8XOBV4MSGdata must be at least 5 bytes in length to hold this data. The size is DINT[2] or 8 bytes (see [Table 40](#)).

Table 40 - Layout of Instance 852 (354 hex) – 1732ES-IB8XOBV4 Modules

Instance Hex (decimal)	Connection Type	Byte	Bit 7	Bit 6	Bit 5	Bit 4	Bit 3	Bit 2	Bit 1	Bit 0
354 (852)	Safety and standard	0	Safety Input 7	Safety Input 6	Safety Input 5	Safety Input 4	Safety Input 3	Safety Input 2	Safety Input 1	Safety Input 0
		1	Safety Input 7 Status	Safety Input 6 Status	Safety Input 5 Status	Safety Input 4 Status	Safety Input 3 Status	Safety Input 2 Status	Safety Input 1 Status	Safety Input 0 Status
		2	Safety Output 7 Status	Safety Output 6 Status	Safety Output 5 Status	Safety Output 4 Status	Safety Output 3 Status	Safety Output 2 Status	Safety Output 1 Status	Safety Output 0 Status
		3	Safety Output 7 Monitor	Safety Output 6 Monitor	Safety Output 5 Monitor	Safety Output 4 Monitor	Safety Output 3 Monitor	Safety Output 2 Monitor	Safety Output 1 Monitor	Safety Output 0 Monitor
		4	Reserved	Reserved	Input Power Error <sup>(1)</sup>	Output Power Error <sup>(1)</sup>	Reserved	Reserved	Muting Lamp 7 Status	Muting Lamp 3 Status

From the top of the Message Configuration dialog box, click Tag to see this dialog box.

**Figure 68 - Instance 852 Tag Tab**



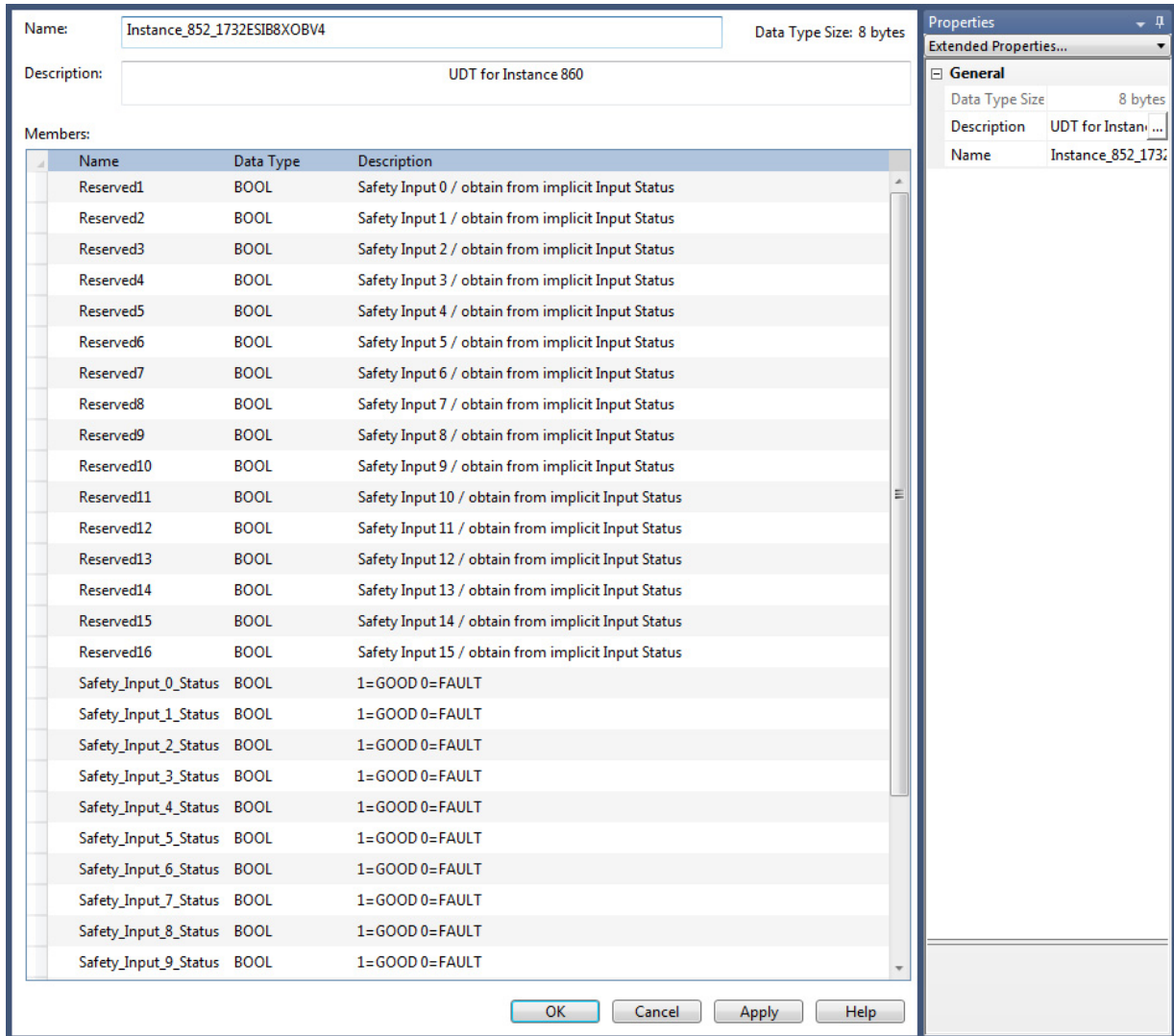
When the explicit message reads the data from the 1732ES-IB8XOBV4 module, the data appears in the MSGdata tags as shown in [Figure 69](#).

**Figure 69 - Instance 852 MSGdata Tags**

IB8XOBV4MSGdata	0	Decimal	DINT
IB8XOBV4MSGdata.0	0	Decimal	BOOL
IB8XOBV4MSGdata.1	0	Decimal	BOOL
IB8XOBV4MSGdata.2	0	Decimal	BOOL
IB8XOBV4MSGdata.3	0	Decimal	BOOL
IB8XOBV4MSGdata.4	0	Decimal	BOOL
IB8XOBV4MSGdata.5	0	Decimal	BOOL
IB8XOBV4MSGdata.6	0	Decimal	BOOL
IB8XOBV4MSGdata.7	0	Decimal	BOOL
IB8XOBV4MSGdata.8	0	Decimal	BOOL
IB8XOBV4MSGdata.9	0	Decimal	BOOL
IB8XOBV4MSGdata.10	0	Decimal	BOOL
IB8XOBV4MSGdata.11	0	Decimal	BOOL
IB8XOBV4MSGdata.12	0	Decimal	BOOL
IB8XOBV4MSGdata.13	0	Decimal	BOOL
IB8XOBV4MSGdata.14	0	Decimal	BOOL
IB8XOBV4MSGdata.15	0	Decimal	BOOL
IB8XOBV4MSGdata.16	0	Decimal	BOOL
IB8XOBV4MSGdata.17	0	Decimal	BOOL
IB8XOBV4MSGdata.18	0	Decimal	BOOL
IB8XOBV4MSGdata.19	0	Decimal	BOOL
IB8XOBV4MSGdata.20	0	Decimal	BOOL
IB8XOBV4MSGdata.21	0	Decimal	BOOL
IB8XOBV4MSGdata.22	0	Decimal	BOOL
IB8XOBV4MSGdata.23	0	Decimal	BOOL
IB8XOBV4MSGdata.24	0	Decimal	BOOL
IB8XOBV4MSGdata.25	0	Decimal	BOOL
IB8XOBV4MSGdata.26	0	Decimal	BOOL
IB8XOBV4MSGdata.27	0	Decimal	BOOL
IB8XOBV4MSGdata.28	0	Decimal	BOOL
IB8XOBV4MSGdata.29	0	Decimal	BOOL
IB8XOBV4MSGdata.30	0	Decimal	BOOL
IB8XOBV4MSGdata.31	0	Decimal	BOOL

The first 32 bits of the instance are in IB8XOBV4MSGdata[0].0...31, and the final 8 bits are in IB8XOBV4MSGdata[1].0...7. Map these 40 bits according to Instance 852. An easy method to do this mapping is to create a user-defined tag (UDT) for Instance 852. Once complete, it appears as shown in [Figure 70](#).

**Figure 70 - Instance 852 UDT**



## I/O Data Supported by Each Module

[Table 41](#) shows a summary of default I/O data by module.

**Table 41 - Default I/O Data**

Module Cat. No.	Safety Connection	Assembly Instance (hex)
1791ES-IB16	Safety	225 and 23
1791ES-IB8XOBV4	Safety	204 and 234
1732ES-IB12XOBV2	Safety	20C and 233
1732ES-IB12XOB4	Safety	20C and 233



**Table 41 - Default I/O Data**

Module Cat. No.	Safety Connection	Assembly Instance (hex)
1732ES-IB16	Safety	205 and 23
1732ES-IB8XOB8	Safety	204 and 22
1732ES-IB8XOBV4	Safety	204 and 22

The tables show the I/O data supported by each module. See [I/O Assembly and Reference Data on page 140](#) for data arrangements.

For I/O data, safety connections for up to four items, including one output, can be allocated for the master unit. Also, standard connections for up to two items can be allocated for the master unit.

**Table 42 - 1791ES-IB8XOBV4 Modules**

Input Data	Input Status	Assembly Instance
Safety	None	204 <sup>(1)</sup>
	Point Status - Muting	334
	Combined Status - Muting	324
Safety - Readback	Point Status - Muting	354
	Point Status - Muting - Test Output	374
Output Data		Assembly Instance
Safety	–	234 <sup>(1)</sup>
Test		22
Combined		2C4
None		C7

(1) The default Assembly Instance.

**Table 43 - 1791ES-IB16 Modules**

Input Data	Input Status	Assembly Instance
Safety	None	205
	Point Status - Muting	335
	Point Status - Muting - Test Output	365
	Combined Status - Muting	315
	Point Status	225 <sup>(1)</sup>
Output Data		Assembly Instance
Test	–	23 <sup>(1)</sup>
None		C7

(1) The default Assembly Instance.

**Table 44 - 1732ES-IB12X0BV2**

Input Data	Input Status	Assembly Instance
Safety	None	20C <sup>(1)</sup>
	Point Status - Muting	34C
	Combined Status - Muting	32C
Safety - Readback	Point Status - Muting	35C
	Point Status - Muting - Test Output	37C
Output Data		Assembly Instance
Safety	-	233 <sup>(1)</sup>
Test		25
Combined		3C4
None		C7

(1) The default Assembly Instance.

**Table 45 - 1732ES-IB12X0BV4**

Input Data	Input Status	Assembly Instance
Safety	None	20C <sup>(1)</sup>
	Point Status - Muting	34C
	Combined Status - Muting	32C
Safety - Readback	Point Status - Muting	35C
	Point Status - Muting - Test Output	37C
Output Data		Assembly Instance
Safety	-	233 <sup>(1)</sup>
Test		25
Combined		3C4
None		C7

(1) The default Assembly Instance.

**Table 46 - 1732ES-IB16 Modules**

Input Data	Input Status	Assembly Instance
Safety	None	205
	Point Status - Muting	335
	Point Status - Muting - Test Output	365
	Combined Status - Muting	315
	Point Status	225 <sup>(1)</sup>
Output Data		Assembly Instance
Test	-	23 <sup>(1)</sup>
None		C7

(1) The default Assembly Instance.

**Table 47 - 1732ES-IB8XOBV4 Modules**

<b>Input Data</b>	<b>Input Status</b>	<b>Assembly Instance</b>
Safety	None	204 <sup>(1)</sup>
	Point Status - Muting	344
	Combined Status - Muting	324
Safety - Readback	Point Status - Muting	354
	Point Status - Muting - Test Output	374
<b>Output Data</b>		<b>Assembly Instance</b>
Safety	-	234 <sup>(1)</sup>
Test		22
Combined		2C4
None		C7

(1) The default Assembly Instance.

**Table 48 - 1732ES-IB8XOB8 Modules**

<b>Input Data</b>	<b>Input Status</b>	<b>Assembly Instance</b>
Safety	None	204 <sup>(1)</sup>
	Point Status - Muting	344
	Combined Status - Muting	324
Safety - Readback	Point Status - Muting	354
	Point Status - Muting - Test Output	374
<b>Output Data</b>		<b>Assembly Instance</b>
Safety	-	234 <sup>(1)</sup>
Test		22
Combined		2C4
None		C7

(1) The default Assembly Instance.

## I/O Assembly and Reference Data

This section provides information for I/O assembly and reference data.

### 1791ES Modules

The bits in the tag definitions of the programming software are different than the bits shown in the following section. [Table 49](#) defines the name associations for clarification with the programming software.

**Table 49 - Bit Definitions and Programming Software Tag Names**

Bit Definitions	Programming Software Tag Name
Safety Input 0	Pt00Data
Safety Input 15	Pt15Data
Safety Input 0 Status	Pt00InputStatus
Safety Input 15 Status	Pt15InputStatus
Safety In Status	InputStatus
Muting Lamp Status	MutingStatus
Safety Output 0	Pt00Data
Safety Output 7	Pt07Data
Standard Output 0	Test00Data
Standard Output 15	Test15Data
Safety Output 0 Status	Pt00OutputStatus
Safety Output 7 Status	Pt07OutputStatus
Safety Out Status	OutputStatus
Safety Output 0 Monitor	Pt00Readback
Safety Output 7 Monitor	Pt07Readback
Test Output 0 Status	Pt00TestOutputStatus
Test Output 15 Status	Pt15TestOutputStatus

See [Table 50](#)...[Table 53](#) for reference data concerning input and output data.

**Table 50 - Input Data – 1791ES-IB8XOBV4 Modules**

Instance Hex (decimal)	Connection Type	Byte	Bit 7	Bit 6	Bit 5	Bit 4	Bit 3	Bit 2	Bit 1	Bit 0
204 (516)	Safety and standard	0	Safety Input 7	Safety Input 6	Safety Input 5	Safety Input 4	Safety Input 3	Safety Input 2	Safety Input 1	Safety Input 0
224 (548)	Safety and standard	0	Safety Input 7	Safety Input 6	Safety Input 5	Safety Input 4	Safety Input 3	Safety Input 2	Safety Input 1	Safety Input 0
		1	Safety Input 7 Status	Safety Input 6 Status	Safety Input 5 Status	Safety Input 4 Status	Safety Input 3 Status	Safety Input 2 Status	Safety Input 1 Status	Safety Input 0 Status
301 (769)	Only standard	0	Reserved	Reserved	Reserved	Reserved	Reserved	Reserved	Output Power Error <sup>(1)</sup>	Input Power Error
324 (804)	Safety and standard	0	Safety Input 7	Safety Input 6	Safety Input 5	Safety Input 4	Safety Input 3	Safety Input 2	Safety Input 1	Safety Input 0
		1	Combined Safety In Status	Combined Safety Out Status	Input Power Error <sup>(1)</sup>	Output Power Error <sup>(1)</sup>	Reserved	Reserved	Muting Lamp 7 Status	Muting Lamp 3 Status

**Table 50 - Input Data – 1791ES-IB8XOBV4 Modules (Continued)**

Instance Hex (decimal)	Connection Type	Byte	Bit 7	Bit 6	Bit 5	Bit 4	Bit 3	Bit 2	Bit 1	Bit 0
334 (820)	Safety and standard	0	Safety Input 7	Safety Input 6	Safety Input 5	Safety Input 4	Safety Input 3	Safety Input 2	Safety Input 1	Safety Input 0
		1	Safety Input 7 Status	Safety Input 6 Status	Safety Input 5 Status	Safety Input 4 Status	Safety Input 3 Status	Safety Input 2 Status	Safety Input 1 Status	Safety Input 0 Status
		2	Reserved	Reserved	Input Power Error <sup>(1)</sup>	Output Power Error <sup>(1)</sup>	Reserved	Reserved	Muting Lamp 7 Status	Muting Lamp 3 Status
344 (836)	Safety and standard	0	Safety Input 7	Safety Input 6	Safety Input 5	Safety Input 4	Safety Input 3	Safety Input 2	Safety Input 1	Safety Input 0
		1	Safety Input 7 Status	Safety Input 6 Status	Safety Input 5 Status	Safety Input 4 Status	Safety Input 3 Status	Safety Input 2 Status	Safety Input 1 Status	Safety Input 0 Status
		2	Safety Output 7 Status	Safety Output 6 Status	Safety Output 5 Status	Safety Output 4 Status	Safety Output 3 Status	Safety Output 2 Status	Safety Output 1 Status	Safety Output 0 Status
		3	Reserved	Reserved	Input Power Error <sup>(1)</sup>	Output Power Error <sup>(1)</sup>	Reserved	Reserved	Muting Lamp 7 Status	Muting Lamp 3 Status
354 (852)	Safety and standard	0	Safety Input 7	Safety Input 6	Safety Input 5	Safety Input 4	Safety Input 3	Safety Input 2	Safety Input 1	Safety Input 0
		1	Safety Input 7 Status	Safety Input 6 Status	Safety Input 5 Status	Safety Input 4 Status	Safety Input 3 Status	Safety Input 2 Status	Safety Input 1 Status	Safety Input 0 Status
		2	Safety Output 7 Status	Safety Output 6 Status	Safety Output 5 Status	Safety Output 4 Status	Safety Output 3 Status	Safety Output 2 Status	Safety Output 1 Status	Safety Output 0 Status
		3	Safety Output 7 Monitor	Safety Output 6 Monitor	Safety Output 5 Monitor	Safety Output 4 Monitor	Safety Output 3 Monitor	Safety Output 2 Monitor	Safety Output 1 Monitor	Safety Output 0 Monitor
		4	Reserved	Reserved	Input Power Error <sup>(1)</sup>	Output Power Error <sup>(1)</sup>	Reserved	Reserved	Muting Lamp 7 Status	Muting Lamp 3 Status
364 (868)	Safety and standard	0	Safety Input 7 Status	Safety Input 6 Status	Safety Input 5 Status	Safety Input 4 Status	Safety Input 3 Status	Safety Input 2 Status	Safety Input 1 Status	Safety Input 0 Status
		1	Safety Output 7 Status	Safety Output 6 Status	Safety Output 5 Status	Safety Output 4 Status	Safety Output 3 Status	Safety Output 2 Status	Safety Output 1 Status	Safety Output 0 Status
		2	Test Output 7 Status	Test Output 6 Status	Test Output 5 Status	Test Output 4 Status	Test Output 3 Status	Test Output 2 Status	Test Output 1 Status	Test Output 0 Status
		3	Reserved	Reserved	Input Power Error <sup>(1)</sup>	Output Power Error <sup>(1)</sup>	Reserved	Reserved	Muting Lamp 7 Status	Muting Lamp 3 Status
374 (884)	Safety and standard	0	Safety Input 7	Safety Input 6	Safety Input 5	Safety Input 4	Safety Input 3	Safety Input 2	Safety Input 1	Safety Input 0
		1	Safety Input 7 Status	Safety Input 6 Status	Safety Input 5 Status	Safety Input 4 Status	Safety Input 3 Status	Safety Input 2 Status	Safety Input 1 Status	Safety Input 0 Status
		2	Safety Output 7 Status	Safety Output 6 Status	Safety Output 5 Status	Safety Output 4 Status	Safety Output 3 Status	Safety Output 2 Status	Safety Output 1 Status	Safety Output 0 Status
		3	Safety Output 7 Monitor	Safety Output 6 Monitor	Safety Output 5 Monitor	Safety Output 4 Monitor	Safety Output 3 Monitor	Safety Output 2 Monitor	Safety Output 1 Monitor	Safety Output 0 Monitor
		4	Test Output 7 Status	Test Output 6 Status	Test Output 5 Status	Test Output 4 Status	Test Output 3 Status	Test Output 2 Status	Test Output 1 Status	Test Output 0 Status
		5	Reserved	Reserved	Input Power Error <sup>(1)</sup>	Output Power Error <sup>(1)</sup>	Reserved	Reserved	Muting Lamp 7 Status	Muting Lamp 3 Status
394 (916)	Only standard	0	Reserved	Reserved	Reserved	Reserved	Reserved	Reserved	Output Power Error	Input Power Error
		1	Test Output 7 Status	Test Output 6 Status	Test Output 5 Status	Test Output 4 Status	Test Output 3 Status	Test Output 2 Status	Test Output 1 Status	Test Output 0 Status
3A4 (932)	Only standard	0	Reserved	Reserved	Reserved	Reserved	Reserved	Reserved	Output Power Error	Input Power Error
		1	Safety Output 7 Monitor	Safety Output 6 Monitor	Safety Output 5 Monitor	Safety Output 4 Monitor	Safety Output 3 Monitor	Safety Output 2 Monitor	Safety Output 1 Monitor	Safety Output 0 Monitor
		2	Test Output 7 Status	Test Output 6 Status	Test Output 5 Status	Test Output 4 Status	Test Output 3 Status	Test Output 2 Status	Test Output 1 Status	Test Output 0 Status

(1) This data is only diagnostic data. This data does not have safety integrity.

**Table 51 - Input Data – 1791ES-IB16 Modules**

Instance Hex (decimal)	Connection Type	Byte	Bit 7	Bit 6	Bit 5	Bit 4	Bit 3	Bit 2	Bit 1	Bit 0
205 (517)	Safety and standard	0	Safety Input 7	Safety Input 6	Safety Input 5	Safety Input 4	Safety Input 3	Safety Input 2	Safety Input 1	Safety Input 0
		1	Safety Input 15	Safety Input 14	Safety Input 13	Safety Input 12	Safety Input 11	Safety Input 10	Safety Input 9	Safety Input 8
225 (549)	Safety and standard	0	Safety Input 7	Safety Input 6	Safety Input 5	Safety Input 4	Safety Input 3	Safety Input 2	Safety Input 1	Safety Input 0
		1	Safety Input 15	Safety Input 14	Safety Input 13	Safety Input 12	Safety Input 11	Safety Input 10	Safety Input 9	Safety Input 8
		2	Safety Input 7 Status	Safety Input 6 Status	Safety Input 5 Status	Safety Input 4 Status	Safety Input 3 Status	Safety Input 2 Status	Safety Input 1 Status	Safety Input 0 Status
		3	Safety Input 15 Status	Safety Input 14 Status	Safety Input 13 Status	Safety Input 12 Status	Safety Input 11 Status	Safety Input 10 Status	Safety Input 9 Status	Safety Input 8 Status
300 (768)	Only standard	0	Reserved	Reserved	Reserved	Reserved	Reserved	Reserved	Reserved	Input Power Error
315 (789)	Safety and standard	0	Safety Input 7	Safety Input 6	Safety Input 5	Safety Input 4	Safety Input 3	Safety Input 2	Safety Input 1	Safety Input 0
		1	Safety Input 15 Status	Safety Input 14 Status	Safety Input 13 Status	Safety Input 12 Status	Safety Input 11 Status	Safety Input 10 Status	Safety Input 9 Status	Safety Input 8 Status
		2	Combined Safety In Status	Reserved	Input Power Error <sup>(1)</sup>	Reserved	Muting Lamp 15 Status	Muting Lamp 11 Status	Muting Lamp 7 Status	Muting Lamp 3 Status
335 (821)	Safety and standard	0	Safety Input 7	Safety Input 6	Safety Input 5	Safety Input 4	Safety Input 3	Safety Input 2	Safety Input 1	Safety Input 0
		1	Safety Input 15	Safety Input 14	Safety Input 13	Safety Input 12	Safety Input 11	Safety Input 10	Safety Input 9	Safety Input 8
		2	Safety Input 7 Status	Safety Input 6 Status	Safety Input 5 Status	Safety Input 4 Status	Safety Input 3 Status	Safety Input 2 Status	Safety Input 1 Status	Safety Input 0 Status
		3	Safety Input 15 Status	Safety Input 14 Status	Safety Input 13 Status	Safety Input 12 Status	Safety Input 11 Status	Safety Input 10 Status	Safety Input 9 Status	Safety Input 8 Status
		4	Reserved	Reserved	Input Power Error <sup>(1)</sup>	Reserved	Muting Lamp 15 Status	Muting Lamp 11 Status	Muting Lamp 7 Status	Muting Lamp 3 Status
365 (869)	Safety and standard	0	Safety Input 7	Safety Input 6	Safety Input 5	Safety Input 4	Safety Input 3	Safety Input 2	Safety Input 1	Safety Input 0
		1	Safety Input 15	Safety Input 14	Safety Input 13	Safety Input 12	Safety Input 11	Safety Input 10	Safety Input 9	Safety Input 8
		2	Safety Input 7 Status	Safety Input 6 Status	Safety Input 5 Status	Safety Input 4 Status	Safety Input 3 Status	Safety Input 2 Status	Safety Input 1 Status	Safety Input 0 Status
		3	Safety Input 15 Status	Safety Input 14 Status	Safety Input 13 Status	Safety Input 12 Status	Safety Input 11 Status	Safety Input 10 Status	Safety Input 9 Status	Safety Input 8 Status
		4	Test Output 7 Status	Test Output 6 Status	Test Output 5 Status	Test Output 4 Status	Test Output 3 Status	Test Output 2 Status	Test Output 1 Status	Test Output 0 Status
		5	Test Output 15 Status	Test Output 14 Status	Test Output 13 Status	Test Output 12 Status	Test Output 11 Status	Test Output 10 Status	Test Output 9 Status	Test Output 8 Status
		6	Reserved	Reserved	Input Power Error <sup>(1)</sup>	Output Power Error <sup>(1)</sup>	Muting Lamp 15 Status	Muting Lamp 11 Status	Muting Lamp 7 Status	Muting Lamp 3 Status
385 (901)	Only standard	0	Reserved	Reserved	Reserved	Reserved	Reserved	Reserved	Reserved	Input Power Error
		1	Test Output 7 Status	Test Output 6 Status	Test Output 5 Status	Test Output 4 Status	Test Output 3 Status	Test Output 2 Status	Test Output 1 Status	Test Output 0 Status
		2	Test Output 15 Status	Test Output 14 Status	Test Output 13 Status	Test Output 12 Status	Test Output 11 Status	Test Output 10 Status	Test Output 9 Status	Test Output 8 Status

(1) This data is only diagnostic data. This data does not have safety integrity.

**Table 52 - Output Data – 1791ES-IB8X0VB4 Modules**

Instance Hex (decimal)	Connection Type	Byte	Bit 7	Bit 6	Bit 5	Bit 4	Bit 3	Bit 2	Bit 1	Bit 0
22 (34)	Safety and standard	0	Standard Output 7 <sup>(1)</sup>	Standard Output 6	Standard Output 5	Standard Output 4	Standard Output 3	Standard Output 2	Standard Output 1	Standard Output 0
234 (564)	Only safety	0	Safety Output 7	Safety Output 6	Safety Output 5	Safety Output 4	Safety Output 3	Safety Output 2	Safety Output 1	Safety Output 0
2C4 (708)	Only safety	0	Safety Output 7	Safety Output 6	Safety Output 5	Safety Output 4	Safety Output 3	Safety Output 2	Safety Output 1	Safety Output 0
		1	Standard Output 7	Standard Output 6	Standard Output 5	Standard Output 4	Standard Output 3	Standard Output 2	Standard Output 1	Standard Output 0

(1) Standard output signifies a test output configured as a standard output.

**Table 53 - Output Data – 1791ES-IB16 Modules**

Instance Hex (decimal)	Connection Type	Byte	Bit 7	Bit 6	Bit 5	Bit 4	Bit 3	Bit 2	Bit 1	Bit 0
23 (35)	Safety and standard	0	Standard Output 7	Standard Output 6	Standard Output 5	Standard Output 4	Standard Output 3	Standard Output 2	Standard Output 1	Standard Output 0
		1	Standard Output 15	Standard Output 14	Standard Output 13	Standard Output 12	Standard Output 11	Standard Output 10	Standard Output 9	Standard Output 8

## 1732ES Modules

The bits in the tag definitions of the programming software are different than those bits that are shown in the following section. [Table 54](#) the name associations for clarification with the programming software.

**Table 54 - Bit Definitions and Programming Software Tag Names**

Bit Definitions	Programming Software Tag Name
Safety Input 0...11	<i>ModuleName:1.Pt00Data - Pt11Data</i>
Safety Input 0...11 Status	<i>ModuleName:1.Pt00InputStatus - Pt11InputStatus</i>
Combined Safety In Status	<i>ModuleName:1.InputStatus</i>
Muting Lamp Status	<i>ModuleName:1.MutingStatusXX where XX = 03, 07, 11</i>
Safety Output 0...3	<i>ModuleName:0.Pt00Data - Pt03Data</i>
Safety Output 0...3 Status	<i>ModuleName:1.Pt00OutputStatus - Pt03OutputStatus</i>
Combined Safety Out Status	<i>ModuleName:1.OutputStatus</i>
Safety Output 0...3 Monitor	<i>ModuleName:1.Pt00Readback - Pt03Readback</i>
Test Output 0...11 Data	<i>ModuleName:0.Test00Data - Test11Data</i>
Test Output 0...11 Status	<i>ModuleName:1.Pt00TestOutputStatus - Pt11TestOutputStatus</i>
Input Power Status	<i>ModuleName:1.InputPowerStatus</i>
Output Power Status	<i>ModuleName:1.OutputPowerStatus</i>

See [Table 55...](#)[Table 60](#) for reference data related to input and output data.

**Table 55 - Input Data 1732ES-IB16 Modules**

Instance Hex (decimal)	Connection Type	Byte	Bit 7	Bit 6	Bit 5	Bit 4	Bit 3	Bit 2	Bit 1	Bit 0
205 (517)	Safety and standard	0	Safety Input 7	Safety Input 6	Safety Input 5	Safety Input 4	Safety Input 3	Safety Input 2	Safety Input 1	Safety Input 0
		1	Safety Input 15	Safety Input 14	Safety Input 13	Safety Input 12	Safety Input 11	Safety Input 10	Safety Input 9	Safety Input 8
225 (549)	Safety and standard	0	Safety Input 7	Safety Input 6	Safety Input 5	Safety Input 4	Safety Input 3	Safety Input 2	Safety Input 1	Safety Input 0
		1	Safety Input 15	Safety Input 14	Safety Input 13	Safety Input 12	Safety Input 11	Safety Input 10	Safety Input 9	Safety Input 8
		2	Safety Input 7 Status	Safety Input 6 Status	Safety Input 5 Status	Safety Input 4 Status	Safety Input 3 Status	Safety Input 2 Status	Safety Input 1 Status	Safety Input 0 Status
		3	Safety Input 15 Status	Safety Input 14 Status	Safety Input 13 Status	Safety Input 12 Status	Safety Input 11 Status	Safety Input 10 Status	Safety Input 9 Status	Safety Input 8 Status
300 (768)	Standard only	0	Reserved	Reserved	Reserved	Reserved	Reserved	Reserved	Reserved	Input Power Error
315 (789)	Safety and standard	0	Safety Input 7	Safety Input 6	Safety Input 5	Safety Input 4	Safety Input 3	Safety Input 2	Safety Input 1	Safety Input 0
		1	Safety Input 15	Safety Input 14	Safety Input 13	Safety Input 12	Safety Input 11	Safety Input 10	Safety Input 9	Safety Input 8
		2	Combined Safety In Status	Reserved	Input Power Error <sup>(1)</sup>	Reserved	Muting Lamp 15 Status	Muting Lamp 11 Status	Muting Lamp 7 Status	Muting Lamp 3 Status
335 (821)	Safety and standard	0	Safety Input 7	Safety Input 6	Safety Input 5	Safety Input 4	Safety Input 3	Safety Input 2	Safety Input 1	Safety Input 0
		1	Safety Input 15	Safety Input 14	Safety Input 13	Safety Input 12	Safety Input 11	Safety Input 10	Safety Input 9	Safety Input 8
		2	Safety Input 7 Status	Safety Input 6 Status	Safety Input 5 Status	Safety Input 4 Status	Safety Input 3 Status	Safety Input 2 Status	Safety Input 1 Status	Safety Input 0 Status
		3	Safety Input 15 Status	Safety Input 14 Status	Safety Input 13 Status	Safety Input 12 Status	Safety Input 11 Status	Safety Input 10 Status	Safety Input 9 Status	Safety Input 8 Status
		4	Reserved	Reserved	Input Power Error <sup>(1)</sup>	Reserved	Muting Lamp 15 Status	Muting Lamp 11 Status	Muting Lamp 7 Status	Muting Lamp 3 Status
365 (869)	Safety and standard	0	Safety Input 7	Safety Input 6	Safety Input 5	Safety Input 4	Safety Input 3	Safety Input 2	Safety Input 1	Safety Input 0
		1	Safety Input 15	Safety Input 14	Safety Input 13	Safety Input 12	Safety Input 11	Safety Input 10	Safety Input 9	Safety Input 8
		2	Safety Input 7 Status	Safety Input 6 Status	Safety Input 5 Status	Safety Input 4 Status	Safety Input 3 Status	Safety Input 2 Status	Safety Input 1 Status	Safety Input 0 Status
		3	Safety Input 15 Status	Safety Input 14 Status	Safety Input 13 Status	Safety Input 12 Status	Safety Input 11 Status	Safety Input 10 Status	Safety Input 9 Status	Safety Input 8 Status
		4	Test Output 7 Status	Test Output 6 Status	Test Output 5 Status	Test Output 4 Status	Test Output 3 Status	Test Output 2 Status	Test Output 1 Status	Test Output 0 Status
		5	Test Output 15 Status	Test Output 14 Status	Test Output 13 Status	Test Output 12 Status	Test Output 11 Status	Test Output 10 Status	Test Output 9 Status	Test Output 8 Status
		6	Reserved	Reserved	Input Power Error <sup>(1)</sup>	Reserved	Muting Lamp 15 Status	Muting Lamp 11 Status	Muting Lamp 7 Status	Muting Lamp 3 Status
385 (901)	Standard only	0	Reserved	Reserved	Reserved	Reserved	Reserved	Reserved	Reserved	Input Power Error
		1	Test Output 7 Status	Test Output 6 Status	Test Output 5 Status	Test Output 4 Status	Test Output 3 Status	Test Output 2 Status	Test Output 1 Status	Test Output 0 Status
		2	Test Output 15 Status	Test Output 14 Status	Test Output 13 Status	Test Output 12 Status	Test Output 11 Status	Test Output 10 Status	Test Output 9 Status	Test Output 8 Status

(1) This data is only diagnostic data. This data does not have safety integrity.



**Table 56 - Input Data 1732ES-IB8XOBV4 and 1732ES-IB8XOB8 Modules**

Instance Hex (decimal)	Connection Type	Byte	Bit 7	Bit 6	Bit 5	Bit 4	Bit 3	Bit 2	Bit 1	Bit 0
204 (516)	Safety and standard	0	Safety Input 7	Safety Input 6	Safety Input 5	Safety Input 4	Safety Input 3	Safety Input 2	Safety Input 1	Safety Input 0
224 (548)	Safety and standard	0	Safety Input 7	Safety Input 6	Safety Input 5	Safety Input 4	Safety Input 3	Safety Input 2	Safety Input 1	Safety Input 0
		1	Safety Input 7 Status	Safety Input 6 Status	Safety Input 5 Status	Safety Input 4 Status	Safety Input 3 Status	Safety Input 2 Status	Safety Input 1 Status	Safety Input 0 Status
301 (769)	Only standard	0	Reserved	Reserved	Reserved	Reserved	Reserved	Reserved	Output Power Error	Input Power Error
324 (804)	Safety and standard	0	Safety Input 7	Safety Input 6	Safety Input 5	Safety Input 4	Safety Input 3	Safety Input 2	Safety Input 1	Safety Input 0
		1	Combined Safety In Status	Combined Safety Out Status	Input Power Error <sup>(1)</sup>	Output Power Error <sup>(1)</sup>	Reserved	Reserved	Muting Lamp 7 Status	Muting Lamp 3 Status
334 (820)	Safety and standard	0	Safety Input 7	Safety Input 6	Safety Input 5	Safety Input 4	Safety Input 3	Safety Input 2	Safety Input 1	Safety Input 0
		1	Safety Input 7 Status	Safety Input 6 Status	Safety Input 5 Status	Safety Input 4 Status	Safety Input 3 Status	Safety Input 2 Status	Safety Input 1 Status	Safety Input 0 Status
		2	Reserved	Reserved	Input Power Error <sup>(1)</sup>	Output Power Error <sup>(1)</sup>	Reserved	Reserved	Muting Lamp 7 Status	Muting Lamp 3 Status
344 (836)	Safety and standard	0	Safety Input 7	Safety Input 6	Safety Input 5	Safety Input 4	Safety Input 3	Safety Input 2	Safety Input 1	Safety Input 0
		1	Safety Input 7 Status	Safety Input 6 Status	Safety Input 5 Status	Safety Input 4 Status	Safety Input 3 Status	Safety Input 2 Status	Safety Input 1 Status	Safety Input 0 Status
		2	Safety Output 7 Status	Safety Output 6 Status	Safety Output 5 Status	Safety Output 4 Status	Safety Output 3 Status	Safety Output 2 Status	Safety Output 1 Status	Safety Output 0 Status
		3	Reserved	Reserved	Input Power Error <sup>(1)</sup>	Output Power Error <sup>(1)</sup>	Reserved	Reserved	Muting Lamp 7 Status	Muting Lamp 3 Status
354 (852)	Safety and standard	0	Safety Input 7	Safety Input 6	Safety Input 5	Safety Input 4	Safety Input 3	Safety Input 2	Safety Input 1	Safety Input 0
		1	Safety Input 7 Status	Safety Input 6 Status	Safety Input 5 Status	Safety Input 4 Status	Safety Input 3 Status	Safety Input 2 Status	Safety Input 1 Status	Safety Input 0 Status
		2	Safety Output 7 Status	Safety Output 6 Status	Safety Output 5 Status	Safety Output 4 Status	Safety Output 3 Status	Safety Output 2 Status	Safety Output 1 Status	Safety Output 0 Status
		3	Safety Output 7 Monitor	Safety Output 6 Monitor	Safety Output 5 Monitor	Safety Output 4 Monitor	Safety Output 3 Monitor	Safety Output 2 Monitor	Safety Output 1 Monitor	Safety Output 0 Monitor
		4	Reserved	Reserved	Input Power Error <sup>(1)</sup>	Output Power Error <sup>(1)</sup>	Reserved	Reserved	Muting Lamp 7 Status	Muting Lamp 3 Status
364 (868)	Safety and standard	0	Safety Input 7	Safety Input 6	Safety Input 5	Safety Input 4	Safety Input 3	Safety Input 2	Safety Input 1	Safety Input 0
		1	Safety Input 7 Status	Safety Input 6 Status	Safety Input 5 Status	Safety Input 4 Status	Safety Input 3 Status	Safety Input 2 Status	Safety Input 1 Status	Safety Input 0 Status
		2	Test Output 7 Status	Test Output 6 Status	Test Output 5 Status	Test Output 4 Status	Test Output 3 Status	Test Output 2 Status	Test Output 1 Status	Test Output 0 Status
		3	Reserved	Reserved	Input Power Error <sup>(1)</sup>	Output Power Error <sup>(1)</sup>	Reserved	Reserved	Muting Lamp 7 Status	Muting Lamp 3 Status
374 (884)	Safety and standard	0	Safety Input 7	Safety Input 6	Safety Input 5	Safety Input 4	Safety Input 3	Safety Input 2	Safety Input 1	Safety Input 0
		1	Safety Input 7 Status	Safety Input 6 Status	Safety Input 5 Status	Safety Input 4 Status	Safety Input 3 Status	Safety Input 2 Status	Safety Input 1 Status	Safety Input 0 Status
		2	Safety Output 7 Status	Safety Output 6 Status	Safety Output 5 Status	Safety Output 4 Status	Safety Output 3 Status	Safety Output 2 Status	Safety Output 1 Status	Safety Output 0 Status
		3	Safety Output 7 Monitor	Safety Output 6 Monitor	Safety Output 5 Monitor	Safety Output 4 Monitor	Safety Output 3 Monitor	Safety Output 2 Monitor	Safety Output 1 Monitor	Safety Output 0 Monitor
		4	Test Output 7 Status	Test Output 6 Status	Test Output 5 Status	Test Output 4 Status	Test Output 3 Status	Test Output 2 Status	Test Output 1 Status	Test Output 0 Status
		6	Reserved	Reserved	Input Power Error <sup>(1)</sup>	Output Power Error <sup>(1)</sup>	Reserved	Reserved	Muting Lamp 7 Status	Muting Lamp 3 Status

**Table 56 - Input Data 1732ES-IB8XOBV4 and 1732ES-IB8XOB8 Modules (Continued)**

Instance Hex (decimal)	Connection Type	Byte	Bit 7	Bit 6	Bit 5	Bit 4	Bit 3	Bit 2	Bit 1	Bit 0
394 (916)	Only standard	0	Reserved	Reserved	Reserved	Reserved	Reserved	Reserved	Output Power Error	Input Power Error
		1	Test Output 7 Status	Test Output 6 Status	Test Output 5 Status	Test Output 4 Status	Test Output 3 Status	Test Output 2 Status	Test Output 1 Status	Test Output 0 Status
3A4 (932)	Only standard	0	Reserved	Reserved	Reserved	Reserved	Reserved	Reserved	Output Power Error	Input Power Error
		1	Safety Output 7 Monitor	Safety Output 6 Monitor	Safety Output 5 Monitor	Safety Output 4 Monitor	Safety Output 3 Monitor	Safety Output 2 Monitor	Safety Output 1 Monitor	Safety Output 0 Monitor
		2	Test Output 7 Status	Test Output 6 Status	Test Output 5 Status	Test Output 4 Status	Test Output 3 Status	Test Output 2 Status	Test Output 1 Status	Test Output 0 Status

(1) This data is only diagnostic data. This data does not have safety integrity.

**Table 57 - Input Data – 1732ES-IB12XOBV2 and 1732ES-IB12XOB4 Modules**

Instance Hex (decimal)	Connection Type	Byte	Bit 7	Bit 6	Bit 5	Bit 4	Bit 3	Bit 2	Bit 1	Bit 0
20C (524)	Only safety	0	Safety Input 7	Safety Input 6	Safety Input 5	Safety Input 4	Safety Input 3	Safety Input 2	Safety Input 1	Safety Input 0
		1	Reserved	Reserved	Reserved	Reserved	Safety Input 11	Safety Input 10	Safety Input 9	Safety Input 8
22C (556)	Only safety	0	Safety Input 7	Safety Input 6	Safety Input 5	Safety Input 4	Safety Input 3	Safety Input 2	Safety Input 1	Safety Input 0
		1	Safety Input 3 Status	Safety Input 2 Status	Safety Input 1 Status	Safety Input 0 Status	Safety Input 11	Safety Input 10	Safety Input 9	Safety Input 8
		2	Safety Input 11 Status	Safety Input 10 Status	Safety Input 9 Status	Safety Input 8 Status	Safety Input 7 Status	Safety Input 6 Status	Safety Input 5 Status	Safety Input 4 Status
301 (769)	Only standard	0	Reserved	Reserved	Reserved	Reserved	Reserved	Reserved	Output Power Error	Input Power Error
32C (812)	Safety and standard	0	Safety Input 7	Safety Input 6	Safety Input 5	Safety Input 4	Safety Input 3	Safety Input 2	Safety Input 1	Safety Input 0
		1	Reserved	Reserved	Reserved	Reserved	Safety Input 11	Safety Input 10	Safety Input 9	Safety Input 8
		2	Combined Safety In Status	Combined Safety Out Status	Input Power Error <sup>(1)</sup>	Output Power Error <sup>(1)</sup>	Reserved	Muting Lamp 11 Status	Muting Lamp 7 Status	Muting Lamp 3 Status
33C (828)	Safety and standard	0	Safety Input 7	Safety Input 6	Safety Input 5	Safety Input 4	Safety Input 3	Safety Input 2	Safety Input 1	Safety Input 0
		1	Safety Input 3 Status	Safety Input 2 Status	Safety Input 1 Status	Safety Input 0 Status	Safety Input 11	Safety Input 10	Safety Input 9	Safety Input 8
		2	Safety Input 11 Status	Safety Input 10 Status	Safety Input 9 Status	Safety Input 8 Status	Safety Input 7 Status	Safety Input 6 Status	Safety Input 5 Status	Safety Input 4 Status
		3	Reserved	Reserved	Input Power Error <sup>(1)</sup>	Output Power Error <sup>(1)</sup>	Reserved	Muting Lamp 11 Status	Muting Lamp 7 Status	Muting Lamp 3 Status
34C (844)	Safety and standard	0	Safety Input 7	Safety Input 6	Safety Input 5	Safety Input 4	Safety Input 3	Safety Input 2	Safety Input 1	Safety Input 0
		1	Safety Input 3 Status	Safety Input 2 Status	Safety Input 1 Status	Safety Input 0 Status	Safety Input 11	Safety Input 10	Safety Input 9	Safety Input 8
		2	Safety Input 11 Status	Safety Input 10 Status	Safety Input 9 Status	Safety Input 8 Status	Safety Input 7 Status	Safety Input 6 Status	Safety Input 5 Status	Safety Input 4 Status
		3	Reserved	Reserved	Reserved	Reserved	Safety Output 3 Status	Safety Output 2 Status	Safety Output 1 Status	Safety Output 0 Status
		4	Reserved	Reserved	Input Power Error <sup>(1)</sup>	Output Power Error <sup>(1)</sup>	Reserved	Muting Lamp 11 Status	Muting Lamp 7 Status	Muting Lamp 3 Status

**Table 57 - Input Data – 1732ES-IB12X0BV2 and 1732ES-IB12X0B4 Modules (Continued)**

Instance Hex (decimal)	Connection Type	Byte	Bit 7	Bit 6	Bit 5	Bit 4	Bit 3	Bit 2	Bit 1	Bit 0
35C (860)	Safety and standard	0	Safety Input 7	Safety Input 6	Safety Input 5	Safety Input 4	Safety Input 3	Safety Input 2	Safety Input 1	Safety Input 0
		1	Safety Input 3 Status	Safety Input 2 Status	Safety Input 1 Status	Safety Input 0 Status	Safety Input 11	Safety Input 10	Safety Input 9	Safety Input 8
		2	Safety Input 11 Status	Safety Input 10 Status	Safety Input 9 Status	Safety Input 8 Status	Safety Input 7 Status	Safety Input 6 Status	Safety Input 5 Status	Safety Input 4 Status
		3	Safety Output 3 Monitor	Safety Output 2 Monitor	Safety Output 1 Monitor	Safety Output 0 Monitor	Safety Output 3 Status	Safety Output 2 Status	Safety Output 1 Status	Safety Output 0 Status
		4	Reserved	Reserved	Input Power Error <sup>(1)</sup>	Output Power Error <sup>(1)</sup>	Reserved	Muting Lamp 11 Status	Muting Lamp 7 Status	Muting Lamp 3 Status
36C (876)	Safety and standard	0	Safety Input 7	Safety Input 6	Safety Input 5	Safety Input 4	Safety Input 3	Safety Input 2	Safety Input 1	Safety Input 0
		1	Safety Input 3 Status	Safety Input 2 Status	Safety Input 1 Status	Safety Input 0 Status	Safety Input 11	Safety Input 10	Safety Input 9	Safety Input 8
		2	Safety Input 11 Status	Safety Input 10 Status	Safety Input 9 Status	Safety Input 8 Status	Safety Input 7 Status	Safety Input 6 Status	Safety Input 5 Status	Safety Input 4 Status
		3	Test Output 7 Status	Test Output 6 Status	Test Output 5 Status	Test Output 4 Status	Test Output 3 Status	Test Output 2 Status	Test Output 1 Status	Test Output 0 Status
		4	Reserved	Reserved	Reserved	Reserved	Test Output 11 Status	Test Output 10 Status	Test Output 9 Status	Test Output 8 Status
		5	Reserved	Reserved	Input Power Error <sup>(1)</sup>	Output Power Error <sup>(1)</sup>	Reserved	Muting Lamp 11 Status	Muting Lamp 7 Status	Muting Lamp 3 Status
37C (892)	Safety and standard	0	Safety Input 7	Safety Input 6	Safety Input 5	Safety Input 4	Safety Input 3	Safety Input 2	Safety Input 1	Safety Input 0
		1	Safety Input 3 Status	Safety Input 2 Status	Safety Input 1 Status	Safety Input 0 Status	Safety Input 11	Safety Input 10	Safety Input 9	Safety Input 8
		2	Safety Input 11 Status	Safety Input 10 Status	Safety Input 9 Status	Safety Input 8 Status	Safety Input 7 Status	Safety Input 6 Status	Safety Input 5 Status	Safety Input 4 Status
		3	Safety Output 3 Monitor	Safety Output 2 Monitor	Safety Output 1 Monitor	Safety Output 0 Monitor	Safety Output 3 Status	Safety Output 2 Status	Safety Output 1 Status	Safety Output 0 Status
		4	Test Output 7 Status	Test Output 6 Status	Test Output 5 Status	Test Output 4 Status	Test Output 3 Status	Test Output 2 Status	Test Output 1 Status	Test Output 0 Status
		5	Reserved	Reserved	Reserved	Reserved	Test Output 11 Status	Test Output 10 Status	Test Output 9 Status	Test Output 8 Status
		6	Reserved	Reserved	Input Power Error <sup>(1)</sup>	Output Power Error <sup>(1)</sup>	Reserved	Muting Lamp 11 Status	Muting Lamp 7 Status	Muting Lamp 3 Status
39C (924)	Only standard	0	Reserved	Reserved	Reserved	Reserved	Reserved	Reserved	Output Power Error	Input Power Error
		1	Test Output 7 Status	Test Output 6 Status	Test Output 5 Status	Test Output 4 Status	Test Output 3 Status	Test Output 2 Status	Test Output 1 Status	Test Output 0 Status
		2	Reserved	Reserved	Reserved	Reserved	Test Output 11 Status	Test Output 10 Status	Test Output 9 Status	Test Output 8 Status
3AC (940)	Only standard	0	Reserved	Reserved	Reserved	Reserved	Reserved	Reserved	Output Power Error	Input Power Error
		1	Test Output 3 Status	Test Output 2 Status	Test Output 1 Status	Test Output 0 Status	Safety Output 3 Monitor	Safety Output 2 Monitor	Safety Output 1 Monitor	Safety Output 0 Monitor
		2	Test Output 11 Status	Test Output 10 Status	Test Output 9 Status	Test Output 8 Status	Test Output 7 Status	Test Output 6 Status	Test Output 5 Status	Test Output 4 Status

(1) This data is only diagnostic data. This data does not have safety integrity.

**Table 58 - Output Data 1732ES-IB16 Modules**

Instance Hex (decimal)	Connection Type	Byte	Bit 7	Bit 6	Bit 5	Bit 4	Bit 3	Bit 2	Bit 1	Bit 0
23 (35)	Safety and standard	0	Standard Output 7	Standard Output 6	Standard Output 5	Standard Output 4	Standard Output 3	Standard Output 2	Standard Output 1	Standard Output 0
		1	Standard Output 15	Standard Output 14	Standard Output 13	Standard Output 12	Standard Output 11	Standard Output 10	Standard Output 9	Standard Output 8

**Table 59 - Output Data 1732ES-IB8X0BV4 and 1732ES-IB8X0B8 Modules**

Instance Hex (decimal)	Connection Type	Byte	Bit 7	Bit 6	Bit 5	Bit 4	Bit 3	Bit 2	Bit 1	Bit 0
22 (34)	Safety and standard	0	Standard Output 7	Standard Output 6	Standard Output 5	Standard Output 4	Standard Output 3	Standard Output 2	Standard Output 1	Standard Output 0
234 (564)	Only safety	0	Safety Output 7	Safety Output 6	Safety Output 5	Safety Output 4	Safety Output 3	Safety Output 2	Safety Output 1	Safety Output 0
2C4 (708)	Safety and standard	0	Safety Output 7	Safety Output 6	Safety Output 5	Safety Output 4	Safety Output 3	Safety Output 2	Safety Output 1	Safety Output 0
		1	Standard Output 7	Standard Output 6	Standard Output 5	Standard Output 4	Standard Output 3	Standard Output 2	Standard Output 1	Standard Output 0

**Table 60 - Output Data 1732ES-IB12X0BV2 and 1732ES-IB12X0B4 Modules**

Instance Hex (decimal)	Connection Type	Byte	Bit 7	Bit 6	Bit 5	Bit 4	Bit 3	Bit 2	Bit 1	Bit 0
25 (37)	Only standard	0	Standard Output 7	Standard Output 6	Standard Output 5	Standard Output 4	Standard Output 3	Standard Output 2	Standard Output 1	Standard Output 0
		1	Reserved	Reserved	Reserved	Reserved	Standard Output 11	Standard Output 10	Standard Output 9	Standard Output 8
233 (563)	Only safety	0	Reserved	Reserved	Reserved	Reserved	Safety Output 3	Safety Output 2	Safety Output 1	Safety Output 0
3C4 (964)	Safety and standard	0	Standard Output 3	Standard Output 2	Standard Output 1	Standard Output 0	Safety Output 3	Safety Output 2	Safety Output 1	Safety Output 0
		1	Standard Output 11	Standard Output 10	Standard Output 9	Standard Output 8	Standard Output 7	Standard Output 6	Standard Output 5	Standard Output 4

## Explicit Messages

Explicit Messaging can also be used to read individual channel status for safety inputs, safety outputs, test outputs, and power status. You can also configure communication error settings for test outputs.

**Table 61 - Reading the Cause of the Safety Input Error**

Explicit Message	Service	Function	Command (hex)					Response (hex)
			Service Code	Class ID	Instance ID	Attribute ID	Data Size	
Safety input cause of error (fault) information read	Get attribute Single	Reads the cause for the status bit (1...n), specified by the Instance ID, turning OFF.	0E	3D	01...n	6E	-	0: No error 01: Configuration invalid 02: External test signal error 03: Internal input error 04: Discrepancy error 05: Error in the other dual channel input

**Table 62 - Reading the Cause of the Safety Output Error**

Explicit Message	Service	Function	Command (hex)					Response (hex)
			Service Code	Class ID	Instance ID	Attribute ID	Data Size	
Safety output cause of error (fault) information	Get attribute single	Reads the cause for the status bit (1...n), specified by the Instance ID, turning OFF.	0E	3B	01...n	6E	-	0: No error 01: Configuration invalid 02: Over current detected 03: Short circuit detected 04: Output ON error 05: Error in the other dual channel output 08: Output data error 09: Short circuit detected at safety output

**Table 63 - Monitoring the Test Output Point**

Explicit Message	Service	Function	Command (hex)					Response (hex)
			Service Code	Class ID	Instance ID	Attribute ID	Data Size	
Test output cause of error (fault) information	Get attribute single	Reads the cause for the status bit (1...n), specified by the Instance ID, turning OFF.	0E	09	01...n	76	-	0 = No error 01: Configuration invalid 02: Overload detected 05: Output ON error 06: Undercurrent detected for muting lamp

**Table 64 - Setting Hold/Clear for Communications Errors (test output)**

Explicit Message	Service	Function	Command (hex)					Response (hex)
			Service Code	Class ID	Instance ID	Attribute ID	Data Size	
Setting for output state (hold or clear) after communication error	Get attribute single	Reads whether hold or clear is set as the output state after a communication error for a test output specified by the instance ID. The setting can be read for a specified number of points.	0E	09	01...08	05	–	1 byte 00: Clear 01: Hold
Setting for output state (hold or clear) after communication error	Set attribute single	Sets whether hold or clear as the output status after a communication error for an output specified by the instance ID. Sets whether a test output must hold its state or clear (turn off) after a communication error.	10	09	01...08	05	1 byte 00: Clear 01: Hold	

## Safety Data

This appendix lists calculated values for probability of failure on demand (PFD), probability of failure per hour (PFH), and mean time to failure (MTTF). PFD and PFH calculations comply with IEC 61508, edition 2, 2010.

### Calculated Values

Calculated values of probability of failure on demand and probability of failure per hour appear in [Table 65](#). These values must be calculated for the devices within the system to comply with the SIL level required for application.

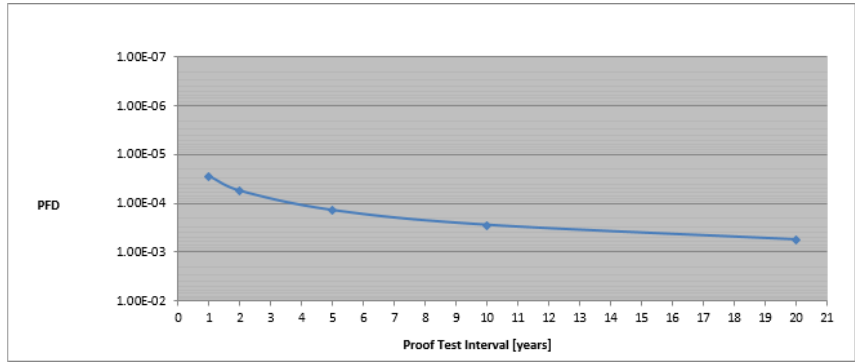
You are responsible for following the requirements of ISO 13849-1:2008 to assess performance levels in your safety system.

Functionally test every I/O module by individually toggling each input point and verify that the controller detects it within the proof test interval.

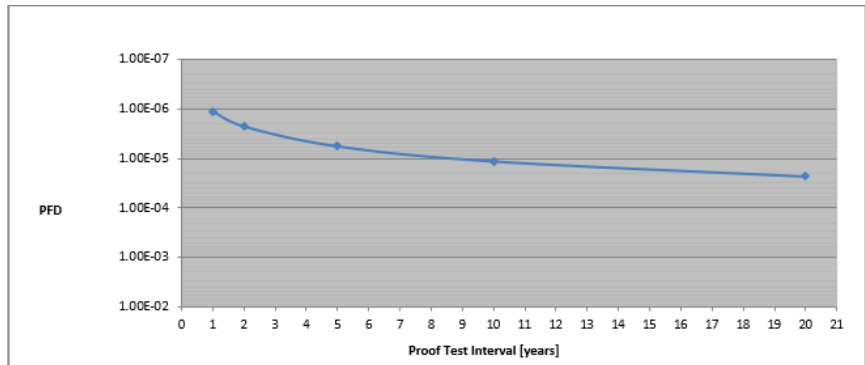
Additionally, individually toggle each output point with the controller and verify that the output point changes state.

For more information, see the appropriate GuardLogix® Safety Reference Manual, which is listed in the [Additional Resources on page 10](#).

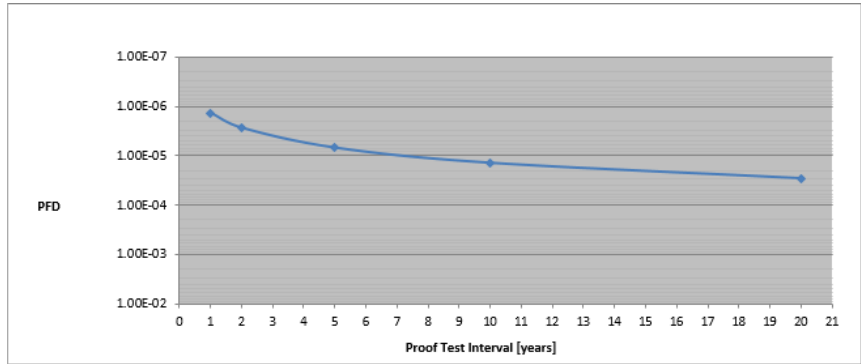
**Figure 24 - PFD vs. Proof Test Interval 1791ES-IB8XOBV4 Single Channel Inputs**



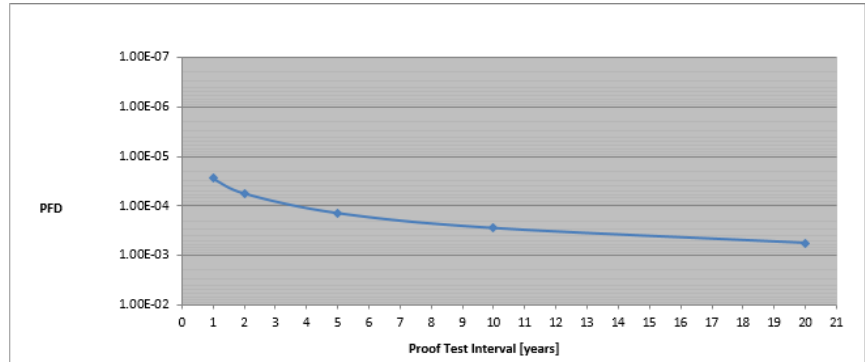
**Figure 25 - PFD vs. Proof Test Interval 1791ES-IB8XOBV4 Dual Channel Inputs**



**Figure 26 - PFD vs. Proof Test Interval 1791ES-IB8XOBV4 Dual Channel Outputs**

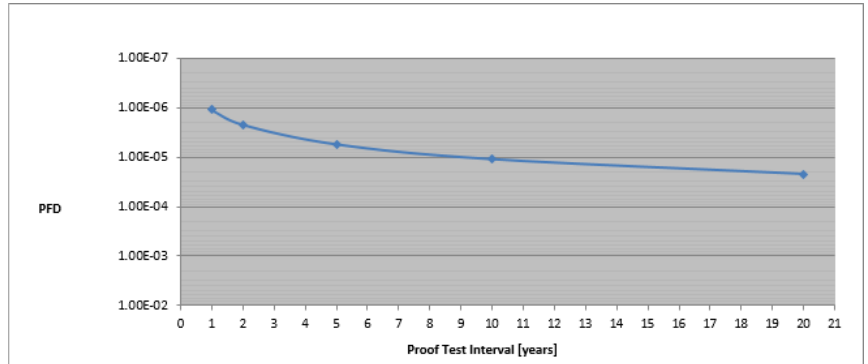


**Figure 27 - PFD vs. Proof Test Interval 1791ES-IB16 Single Channel Inputs**

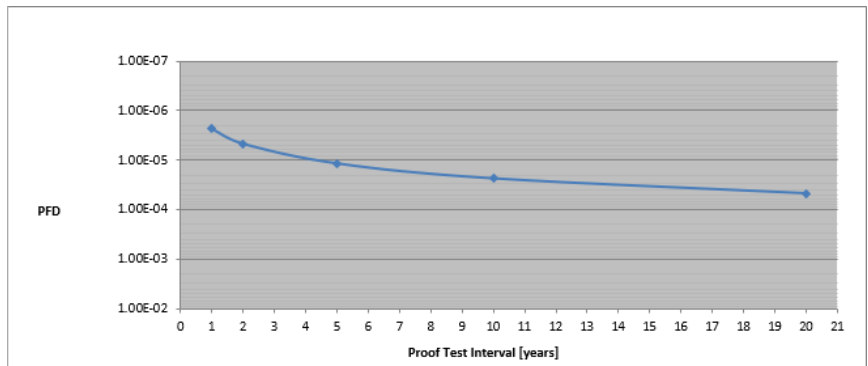




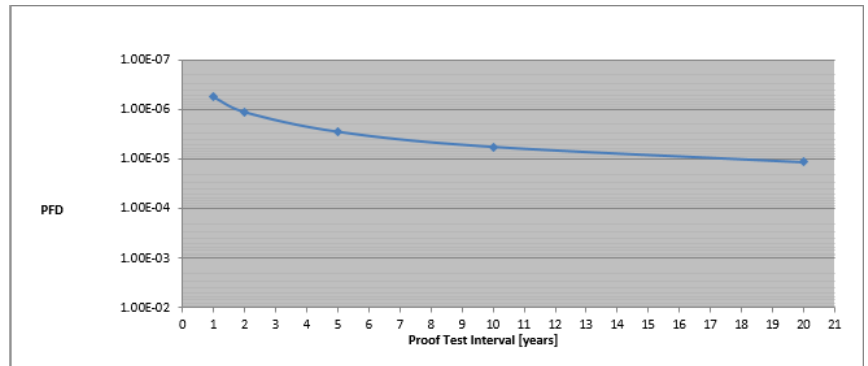
**Figure 28 - PFD vs. Proof Test Interval 1791ES-IB16 Dual Channel Inputs**



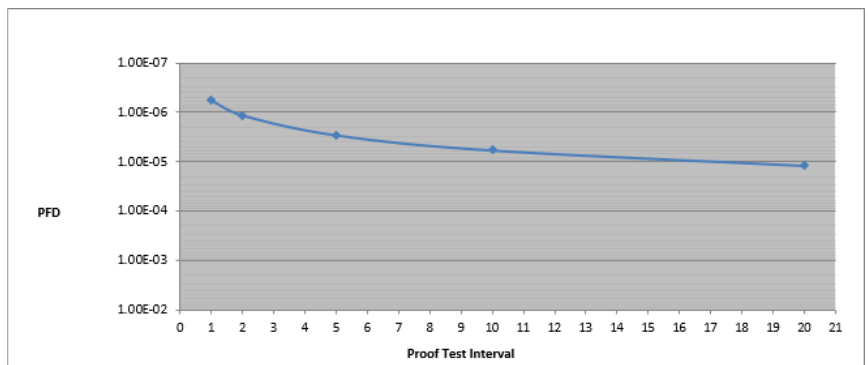
**Figure 29 - PFD vs. Proof Test Interval 1732ES-IB12X0BV2, 1732ES-IB12X0B4, 1732ES-IB8X0BV4, 1732ES-IB8X0B8, 1732ES-IB16 - Single Channel Inputs**



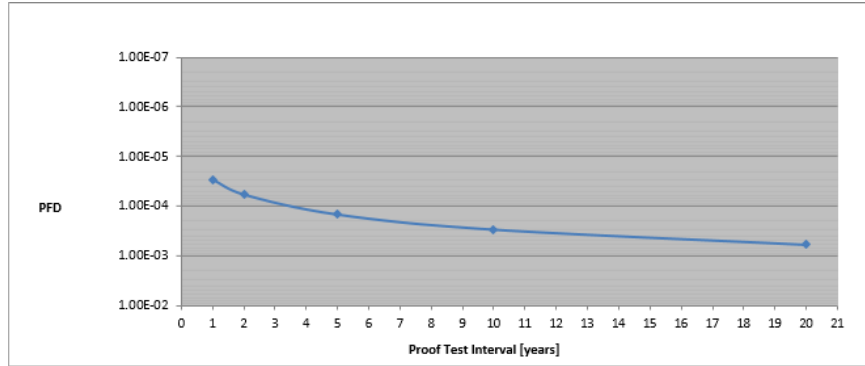
**Figure 30 - PFD vs. Proof Test Interval 1732ES-IB12X0BV2, 1732ES-IB12X0B4, 1732ES-IB8X0BV4, 1732ES-IB8X0B8, 1732ES-IB16 - Dual Channel Inputs**



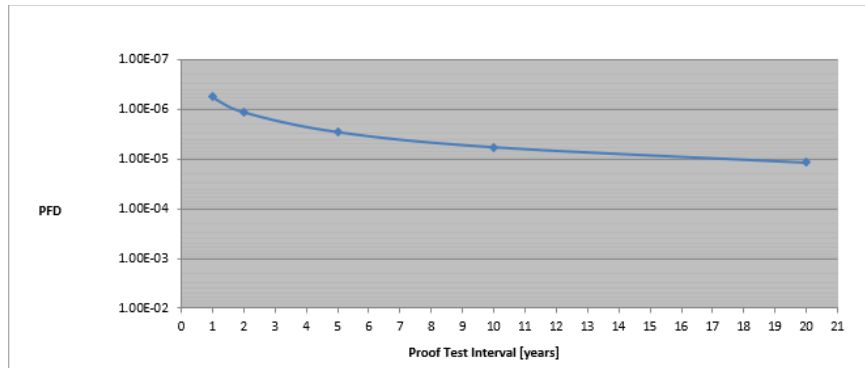
**Figure 31 - PFD vs. Proof Test Interval 1732ES-IB12X0BV2, 1732ES-IB8X0BV4 - Dual Channel Outputs**



**Figure 32 - PFD vs. Proof Test Interval 1732ES-IB12X0B4, 1732ES-IB8X0B8 - Single Channel Outputs<sup>(1)</sup>**



**Figure 33 - PFD vs. Proof Test Interval 1732ES-IB12X0B4, 1732ES-IB8X0B8 - Dual Channel Output**



(1) Single channel output mode is only valid for applications with Process Safety Times  $\geq 600\text{msec}$  OR with Demand Rates  $\leq 1$  Demand per Minute.

**Table 65 - Calculated Values for Probability of Failure on Demand (PFD), Probability of Failure per Hour (PFH), and Mean Time To Failure (MTTF)**

Cat. No.	Proof Test Interval (Mission Time <sup>(2)</sup> )		PFD	PFH (1/hour)	Spurious Trip Rate (STR) <sup>(3)</sup>	MTTF <sub>Spurious</sub> <sup>(4)</sup> (years)
	Year	Hour				
1791ES-IB8XOBV4 Single Channel Inputs	1	8760	2.81E-05	6.41E-09	5.612E-06	20.33
	2	17520	5.61E-05			
	5	43800	1.40E-04			
	10	87600	2.81E-04			
	20	175200	5.61E-04			
1791ES-IB8XOBV4 Dual Channel Inputs	1	8760	1.12E-06	2.63E-10		
	2	17520	2.25E-06			
	5	43800	5.64E-06			
	10	87600	1.13E-05			
	20	175200	2.27E-05			
1791ES-IB8XOBV4 Dual Channel Outputs	1	8760	1.38E-06	3.38E-10		
	2	17520	2.76E-06			
	5	43800	6.95E-06			
	10	87600	1.41E-05			
	20	175200	2.89E-05			
1791ES-IB16 Single Channel Inputs	1	8760	2.80E-05	6.40E-09	3.309E-06	34.48
	2	17520	5.60E-05			
	5	43800	1.40E-04			
	10	87600	2.80E-04			
	20	175200	5.60E-04			
1791ES-IB16 Dual Channel Inputs	1	8760	1.10E-06	2.60E-10		
	2	17520	2.20E-06			
	5	43800	5.50E-06			
	10	87600	1.10E-05			
	20	175200	2.20E-05			
1732ES-IB12XOBV2 Single Channel Inputs	1	8760	2.32E-06	5.38E-10	6.791E-06	16.81
	2	17520	4.63E-06			
	5	43800	1.16E-05			
	10	87600	2.33E-05			
	20	175200	4.69E-05			
1732ES-IB12XOBV2 Dual Channel Inputs	1	8760	5.51E-07	1.35E-10		
	2	17520	1.11E-06			
	5	43800	2.78E-06			
	10	87600	5.64E-06			
	20	175200	1.16E-05			
1732ES-IB12XOBV2 Dual Channel Outputs	1	8760	5.68E-07	1.43E-10		
	2	17520	1.14E-06			
	5	43800	2.87E-06			
	10	87600	5.81E-06			
	20	175200	1.19E-05			

Cat. No.	Proof Test Interval (Mission Time <sup>(2)</sup> )		PFD	PFH (1/hour)	Spurious Trip Rate (STR) <sup>(3)</sup>	MTTF <sub>Spurious</sub> <sup>(4)</sup> (years)
	Year	Hour				
1732ES-IB12XOB4 Single Channel Inputs	1	8760	2.32E-06	5.38E-10	6.670E-06	17.12
	2	17520	4.63E-06			
	5	43800	1.16E-05			
	10	87600	2.33E-05			
	20	175200	4.69E-05			
1732ES-IB12XOB4 Dual Channel Inputs	1	8760	5.51E-07	1.35E-10		
	2	17520	1.11E-06			
	5	43800	2.78E-06			
	10	87600	5.64E-06			
	20	175200	1.16E-05			
1732ES-IB12XOB4 <sup>(1)</sup> Single Channel Outputs	1	8760	2.95E-05	6.75E-09		
	2	17520	5.91E-05			
	5	43800	1.48E-04			
	10	87600	2.95E-04			
	20	175200	5.91E-04			
1732ES-IB12XOB4 Dual Channel Outputs	1	8760	5.62E-07	1.38E-10		
	2	17520	1.13E-06			
	5	43800	2.84E-06			
	10	87600	5.75E-06			
	20	175200	1.18E-05			
1732ES-IB8XOBV4 Single Channel Inputs	1	8760	2.32E-06	5.38E-10	6.896E-06	16.55
	2	17520	4.63E-06			
	5	43800	1.16E-05			
	10	87600	2.33E-05			
	20	175200	4.69E-05			
1732ES-IB8XOBV4 Dual Channel Inputs	1	8760	5.51E-07	1.35E-10		
	2	17520	1.11E-06			
	5	43800	2.78E-06			
	10	87600	5.64E-06			
	20	175200	1.16E-05			
1732ES-IB8XOBV4 Dual Channel Outputs	1	8760	5.68E-07	1.43E-10		
	2	17520	1.14E-06			
	5	43800	2.87E-06			
	10	87600	5.81E-06			
	20	175200	1.19E-05			

Cat. No.	Proof Test Interval (Mission Time <sup>(2)</sup> )		PFD	PFH (1/hour)	Spurious Trip Rate (STR) <sup>(3)</sup>	MTTF <sup>Spurious</sup> <sup>(4)</sup> (years)
	Year	Hour				
1732ES-IB8XOB8 Single Channel Inputs	1	8760	2.32E-06	5.38E-10	6.813E-06	16.75
	2	17520	4.63E-06			
	5	43800	1.16E-05			
	10	87600	2.33E-05			
	20	175200	4.69E-05			
1732ES-IB8XOB8 Dual Channel Inputs	1	8760	5.51E-07	1.35E-10		
	2	17520	1.11E-06			
	5	43800	2.78E-06			
	10	87600	5.64E-06			
	20	175200	1.16E-05			
1732ES-IB8XOB8 <sup>(1)</sup> Single Channel Outputs	1	8760	2.95E-05	6.75E-09		
	2	17520	5.91E-05			
	5	43800	1.48E-04			
	10	87600	2.95E-04			
	20	175200	5.91E-04			
1732ES-IB8XOB8 Dual Channel Outputs	1	8760	5.62E-07	1.38E-10		
	2	17520	1.13E-06			
	5	43800	2.84E-06			
	10	87600	5.75E-06			
	20	175200	1.18E-05			
1732ES-IB16 Single Channel Inputs	1	8760	2.32E-06	5.38E-10	6.526E-06	17.49
	2	17520	4.63E-06			
	5	43800	1.16E-05			
	10	87600	2.33E-05			
	20	175200	4.69E-05			
1732ES-IB16 Dual Channel Inputs	1	8760	5.51E-07	1.35E-10		
	2	17520	1.11E-06			
	5	43800	2.78E-06			
	10	87600	5.64E-06			
	20	175200	1.16E-05			

- (1) Single channel output mode is only valid for applications with Process Safety Times ≥ 600msec OR with Demand Rates ≤ 1 Demand per Minute.
- (2) Mission time for all modules is 20 years.
- (3) Calculated based on ISA TR-84 method.
- (4) Mean Time to Failure (Spurious).

**Table 66 - Failure Rate Data (failures per hour)<sup>(1)</sup>**

Cat. No.	I/O Configuration	$\lambda_S$	$\lambda_{DD}$	$\lambda_{DU}$
1791ES-OB8XOBV4	Single Channel Inputs	7.8343E-07	7.5766E-07	5.5089E-09
	Dual Channel Inputs	1.1786E-06	1.1552E-06	2.6384E-10
	Dual Channel Outputs	1.7205E-06	1.7009E-06	3.0765E-10
1791ES-IB16	Single Channel Inputs	7.8024E-07	7.5356E-07	5.5087E-09
	Dual Channel Inputs	1.1760E-06	1.1519E-06	2.5974E-10

**Table 66 - Failure Rate Data (failures per hour)<sup>(1)</sup>**

Cat. No.	I/O Configuration	$\lambda_S$	$\lambda_{DD}$	$\lambda_{DU}$
1732ES-IB12XOBV2	Single Channel Inputs	2.7190E-07	2.7190E-07	5.8410E-10
	Dual Channel Inputs	3.0730E-07	3.0730E-07	2.0350E-10
	Dual Channel Outputs	3.7360E-07	3.7360E-07	2.0820E-10
1732ES-IB12XOB4	Single Channel Inputs	2.7190E-07	2.7190E-07	5.8410E-10
	Dual Channel Inputs	3.0730E-07	3.0730E-07	2.0350E-10
	Single Channel Outputs <sup>(2)</sup>	2.8910E-07 <sup>(2)</sup>	2.8910E-07 <sup>(2)</sup>	6.4630E-09 <sup>(2)</sup>
	Dual Channel Outputs	3.5140E-07	3.5140E-07	2.0660E-10
1732ES-IB8XOBV4	Single Channel Inputs	2.7190E-07	2.7190E-07	5.8410E-10
	Dual Channel Inputs	3.0730E-07	3.0730E-07	2.0350E-10
	Dual Channel Outputs	3.7360E-07	3.7360E-07	2.0820E-10
1732ES-IB8XOB8	Single Channel Inputs	2.7190E-07	2.7190E-07	5.8410E-10
	Dual Channel Inputs	3.0730E-07	3.0730E-07	2.0350E-10
	Single Channel Outputs <sup>(2)</sup>	2.8910E-07 <sup>(2)</sup>	2.8910E-07 <sup>(2)</sup>	6.4630E-09 <sup>(2)</sup>
	Dual Channel Outputs	3.5140E-07	3.5140E-07	2.0660E-10
1732ES-IB16	Single Channel Inputs	2.7190E-07	2.7190E-07	5.8410E-10
	Dual Channel Inputs	3.0730E-07	3.0730E-07	2.0350E-10

(1) These failure rates assume that a module's inputs or outputs are represented by a single block in a reliability block diagram (the single channel rates should be applied to the reliability block if the module is configured in Single Channel mode, the dual channel rates should be applied to the reliability block if the module is configured in Dual Channel mode).

(2) Single channel output mode (1732ES-IB12XOB4 and 1732ES-IB8XOB8 only) is only valid for applications with Process Safety Times  $\geq 600$ msec OR with Demand Rates  $\leq 1$  Demand per Minute.

## Configuration Reference Information

The modules have these parameter groups: general parameters, safety input, test output, safety output.

### Parameter Groups

See [Table 67](#)...[Table 70](#) for the settings in each parameter group. All parameters are set by using the Studio 5000 Logix Designer® application.

**Table 67 - General Parameters**

Parameter Name	Value	Description	Default
Safety Output Error Latch Time	0...65,530 ms (in increments of 10 ms)	Safety output errors are latched for this time.	1000 ms
Safety Input Error Latch Time	0...65,530 ms (in increments of 10 ms)	Safety input or test output errors are latched for this time.	1000 ms

**Table 68 - Safety Input Parameters**

Parameter Name	Value	Description
Input Point Operation Type	Single Channel	Use as single channel.
	Dual-channel Equivalent	Use as dual-channel. Normal when both channels are ON or OFF.
	Dual-channel Complementary	Use as dual-channel. Normal when one channel is ON and the other channel is OFF.
Input Point Mode	Not Used	External input device is not connected.
	Safety Test Pulse	Use with a contact output device and in combination with a test output. By using this setting, short circuits between input signal lines and the power supply (positive side) and short circuits between input signal lines can be detected.
	Safety	A solid-state output safety sensor is connected.
	Standard	A standard device, such as a reset switch, is connected.
Safety Input Test Source	Not Used	The test output that is used with the input. n is dependent on the module catalog number.
	Test Output 0 to n	
Input Delay Time Off -> On	0...126 ms (in increments of 6 ms)	Filter time for OFF to ON transition
Input Delay Time On -> Off	0...126 ms (in increments of 6 ms)	Filter time for ON to OFF transition

---

**IMPORTANT** When configuring a test output for Pulse Test mode, verify that the corresponding safety input is configured for safety pulse test.

---

**Table 69 - Test Output Parameters**

Parameter Name	Value	Description	Default
Test Output Mode	Not Used	An external device is not connected.	Not Used
	Standard	The output is connected to a standard device.	
	Pulse Test	A contact output device is connected. Use in combination with a safety input.	
	Power Supply	The power supply of a Safety Sensor is connected. The voltage supplied to I/O power (V, G) is output from the test output terminal.	
	Muting Lamp Output 1791ES-IB8XOBV4, 1732ES-IB8XOBV4, 1732ES-IB8XOB8 modules = T3 and T7 1791ES-IB16, 1732ES-IB16 modules = T3, T7, T11, and T15 1732ES-IB12XOBV2, 1732ES-IB12XOB4 modules = T3, T7, and T11	An indicator is connected and turned ON to detect broken lines in an external indicator.	

**Table 70 - Safety Output Parameters**

Parameter Name	Value	Description	Default
Output Point Mode	Not Used	An external output device is not connected.	Not Used
	Safety	When the output is ON, the test pulse is not output (remains ON).	
	Safety Pulse Test	By using this function, short circuits between output signal lines and the power supply (positive side) and short circuits between output signal lines can be detected.	
Output Point Operation Type	Single Channel <sup>(1)</sup>	Use as single channel.	Dual-channel
	Dual-channel	Use as dual-channel. When both channels are normal, outputs can be turned ON.	

(1) 1732ES-IB12XOB4 and 1732ES-IB8XOB8 modules only.



## Specifications

Topic	Page
Technical Specifications	161
Environmental Specifications	166
Certifications	168
Europe	168
EC Directives	169

### Technical Specifications

This section provides technical specifications for the modules.

#### 1791ES Modules

For 1791ES modules, see [Table 71](#) and [Table 72](#).

**Table 71 - 1791ES-IB16 and 1791ES-IB8X0BV4 Modules – Technical Specifications**

Attribute	Value
Safety input	
Inputs type	Current sinking
Voltage, on-state input, min	11V DC
Current, on-state input, min	3.3 mA
Voltage, off-state input, max	5V DC
Current, off-state, max	1.3 mA
IEC 61131-2 (input type)	Type 3
Pulse test output	
Output type	Current sourcing
Pulse test output current	0.7 A per output 8 A total module at 40 °C (104 °F) 6 A total module at 60 °C (140 °F) for 1791ES-IB8X0BV4 (see <a href="#">Product temperature versus current derating</a> ) 8 A total module at 60 °C (140 °F) for 1791ES-IB16
Residual voltage, max	1.2V
Output leakage current, max	0.1 mA
Short circuit protection	Yes
Current, max	25 mA – current, max (to avoid fault when used as a muted lamp output)
Current, min	5 mA – current, min (at which fault indication is generated when used as a muted lamp output)
Safety output	

**Table 71 - 1791ES-IB16 and 1791ES-IB8XOBV4 Modules – Technical Specifications (Continued)**

Attribute	Value
Output types	Current sourcing/current sinking – bipolar pair
Output current rating	2 A max per point 8 A total module at 40 °C (104 °F) (see temperature versus current derating) 6 A total module at 60 °C (140 °F)
Voltage and current ratings	IN PWR (No Load): 19.2-28.8 Vdc, 190 mA @ 24 Vdc typ. No load Inputs: 11-30Vdc, 3.5mA Test Outputs: 19.2-28.8Vdc, 700mA Sum of P and M Currents: 8 A at 40 °C (104 °F), 6 A at 60 °C (140 °F) P & M Outputs: 19.2-28.8Vdc, 2A; 2.5A Inrush. Max. Current (Input plus Output): 8A@40C, 6A@60C. Operating Temperature: -20 °C to +60 °C (140 °F)
On-state voltage drop	+/- 0.6V
Leakage current	+/- 1.0 mA <sup>(1)</sup>
Internal resistance from P to M terminal	3.25 kΩ
Short circuit detection	Yes (short high and low and cross-circuit fault detection)
Short circuit protection	Electronic
Aggregate current of module	8 A at 40 °C (104 °F), 6 A at 60 °C (140 °F) (see product temperature versus current derating)
Pilot duty rating	2.5 A inrush for 1791ES-IB8XOBV4 module
Number of outputs	4, dual-channel

(1) Includes the presence of one P stuck-high or M stuck-low short.

**Table 72 - 1791ES-IB16 and 1791ES-IB8XOBV4 Modules – General**

Attribute	Value
North American temp code	1791ES-IB8XOBV4: T4A 1791ES-IB16: T5
Enclosure type rating	Meets IP20
Communication current consumption	250 mA at 24V DC
Operating voltage range	19.2 . . . 28.8V DC (24V DC, -20 . . . 20%)
Isolation voltage	1791ES-IB16 - 50V (continuous), basic insulation - type tested at 800V DC for 60 s between input channels and network 1791ES-IB8XOBV4 - 50V (continuous), basic insulation - type tested at 800V DC for 60 s between input and output channels and between I/O and network

**Table 72 - 1791ES-IB16 and 1791ES-IB8X0BV4 Modules – General (Continued)**

Attribute	Value
Product temperature versus current derating	<p>Product Temperature Versus Current Derating (combined current from both input and output supplies)</p>
Wiring category <sup>(1)</sup>	2 - on signal ports, 2 - on power ports, 2 - on communication ports
Wire size	Power and I/O wiring: 0.34...1.5 mm <sup>2</sup> (22...16 AWG) solid or stranded copper wire rated at 75 °C (167 °F) or greater, 1.2 mm (3/64 in.) insulation max
Weight, approx	600 g (1.32 lb)
Dimensions (HxWxD), approx.	80 x 196 x 77 mm (3.2 x 7.7 x 3 in.) with terminal block 77 x 196 x 62 mm (3 x 7.7 x 2.5 in.) without terminal block

(1) Use this Conductor Category information for planning conductor routing. See Industrial Automation Wiring and Grounding Guidelines, publication [1770-4.1](#).

## 1732ES Modules

For 1732ES modules, see [Table 73](#) and [Table 74](#).

**Table 73 - 1732ES-IB16, 1732ES-IB8X0B8, 1732ES-IB8X0BV4, 1732ES-IB12X0B4, and 1732ES-IB12X0BV2 Modules – Technical Specifications**

Attribute	Value
Safety input	
Inputs type	Current sinking
Voltage, on-state input	11...30V DC
Current, on-state input	3.5 mA
Voltage, off-state input, max	5V DC
Current, off-state, max	1 mA
IEC 61131-2 (input type)	Type 3
Pulse test output	
Output type	Current sourcing
Pulse test output current (each) (all 1732ES modules except 1732ES-IB16)	0.7 A max per point at 40 °C (104 °F) 0.3 A max per point at 55 °C (131 °F) See <a href="#">Product temperature versus pulse test output current derating (All 1732ES modules except 1732ES-IB16) on page 165</a> .
Pulse test output current (1732ES-IB16 only)	0.7 A max per point 8.4 A max per module
Residual voltage, max	1.2V

**Table 73 - 1732ES-IB16, 1732ES-IB8XOB8, 1732ES-IB8XOBV4, 1732ES-IB12XOB4, and 1732ES-IB12XOBV2 Modules – Technical Specifications**

Attribute	Value
Output leakage current, max	0.1 mA
Short circuit protection	Yes
Current, max	25 mA – current, max (to avoid fault when used as a muted lamp output)
Current, min	5 mA – current, min (at which fault indication is generated when used as a muted lamp output)
Safety output	
Output types	1732ES-IB12XOBV2, 1732ES-IB8XOBV4: Current sourcing/current sinking bipolar pair 1732ES-IB12XOB4, 1732ES-IB8XOB8: Current sourcing
Output current rating (each)	1732ES-IB12XOBV2, 1732ES-IB8XOBV4: 2 A max per point, bipolar outputs 1732ES-IB12XOB4, 1732ES-IB8XOB8: 1 A max per point, sourcing outputs
On-state voltage drop, max	1.15V
Leakage current	1732ES-IB12XOB4, 1732ES-IB8XOB8: +/-0.1 mA 1732ES-IB12XOBV2, 1732ES-IB8XOBV4: +/-1.0 mA <sup>(1)</sup>
Internal resistance from sourcing to sinking terminal	1732ES-IB12XOBV2, 1732ES-IB8XOBV4: 3.25 kΩ 1732ES-IB12XOB4, 1732ES-IB8XOB8: N/A
Short circuit detection	Yes (short high and low and cross-circuit fault detection)
Short circuit protection	Electronic
Pilot duty rating (1732ES-IB12XOBV2, 1732ES-IB8XOBV4 only)	DC13, 2.5 A inrush
Number of outputs	Safety outputs 1732ES-IB12XOB4 module, 4 sourcing outputs 1732ES-IB12XOBV2 module, 4 bipolar outputs, (2 pairs) 1732ES-IB8XOB8 module, 8 sourcing outputs 1732ES-IB8XOBV4 module, 8 bipolar outputs (4 pairs)
Sensor power output current rating (pins 1, 3, and 5 of each output signal I/O connector)	2 A max per point at 40 °C (104 °F) 1 A max per point at 55 °C (131 °F) See <a href="#">Product temperature versus sensor power current derating (per pin) on page 165</a> .

(1) Includes the presence of one sourcing output stuck-high or sinking output stuck-low fault.

**Table 74 - 1732ES-IB16, 1732ES-IB8XOB8, 1732ES-IB8XOBV4, 1732ES-IB12XOB4, and 1732ES-IB12XOBV2 Modules – General**

Attribute	Value
Enclosure type rating	Meets IP65/IP67 (when marked)
Product current consumption (not including Test output or Safety output load current)	1732ES-IB12XOBV2: <ul style="list-style-type: none"> <li>In power (no load): 19.2...28.8V DC, 175 mA at 24V DC</li> <li>Out power (no load): 19.2...28.8V DC, 65 mA at 24V DC</li> </ul> 1732ES-IB12XOB4: <ul style="list-style-type: none"> <li>In power (no load): 19.2...28.8V DC, 175 mA at 24V DC</li> <li>Out power (no load): 19.2...28.8V DC, 45 mA at 24V DC</li> </ul> 1732ES-IB8XOB8: <ul style="list-style-type: none"> <li>In power (no load): 19.2...28.8V DC, 165 mA at 24V DC</li> <li>Out power (no load): 19.2...28.8V DC, 65 mA at 24V DC</li> </ul> 1732ES-IB8XOBV4: <ul style="list-style-type: none"> <li>In power (no load): 19.2...28.8V DC, 165 mA at 24V DC</li> <li>Out power (no load): 19.2...28.8V DC, 110 mA at 24V DC</li> </ul> 1732ES-IB16: <ul style="list-style-type: none"> <li>In power (no load): 19.2...28.8V DC, 190 mA at 24V DC</li> </ul>
Operating voltage range	19.2...28.8V DC (24V DC, -20...20%)
Module power connector rating	10 A max per pin

**Table 74 - 1732ES-IB16, 1732ES-IB8X0B8, 1732ES-IB8X0BV4, 1732ES-IB12X0B4, and 1732ES-IB12X0BV2 Modules – General (Continued)**

Attribute	Value
Isolation voltage	50V (continuous), Basic Type, Input Power and I/O to Ethernet, Input Power and I/O to Output Power and IO, and Output Power and IO to Ethernet Tested at 707V DC for 60s
Product temperature versus pulse test output current derating (All 1732ES modules except 1732ES-IB16)	<p style="text-align: center;">Product Temperature Versus Pulse Test Output Current Derating</p>
Product temperature versus sensor power current derating (per pin)	<p style="text-align: center;">Product Temperature Versus Sensor Power Current Derating (per pin)</p>
Wiring category <sup>(1)</sup>	2 - on signal ports 2 - on power ports 2 - on communication ports
Weight, approx	786 g (1.73 lb)
Dimensions (HxWxD), approx	70 x 259 x 69 mm (2.8 x 10.2 x 2.7 in.) without cables

(1) Use this Conductor Category information for planning conductor routing. See Industrial Automation Wiring and Grounding Guidelines, publication [1770-4.1](#).

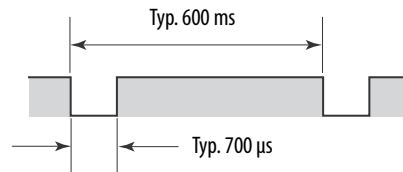
**Environmental Specifications** This section provides environmental specifications for the modules.

- For 1791ES modules, see [Table 75 on page 166](#).
- For 1732ES modules, see [Table 76 on page 167](#).

**Table 75 - 1791ES-IB16 and 1791ES-IB8XOBV4 Modules – Environmental Specifications**

Attribute	Value
Temperature, operating IEC 60068-2-1 (Test Ad, Operating Cold), IEC 60068-2-2 (Test Bd, Operating Dry Heat), IEC 60068-2-14 (Test Nb, Operating Thermal Shock)	-20...+60 °C (-4...+140 °F)
Temperature, nonoperating IEC 60068-2-1 (Test Ab, Unpackaged Nonoperating Cold), IEC 60068-2-2 (Test Bb, Unpackaged Nonoperating Dry Heat), IEC 60068-2-14 (Test Na, Unpackaged Nonoperating Thermal Shock)	-40...+85 °C (-40...+185 °F)
Relative humidity IEC 60068-2-30 (Test Db, Unpackaged Nonoperating Damp Heat)	5...95% noncondensing
Vibration IEC 60068-2-6 (Test Fc, Operating)	5 g at 10...500 Hz
Shock, operating IEC 60068-2-27 (Test Ea, Unpackaged Shock)	30 g
Shock, nonoperating IEC 60068-2-27 (Test Ea, Unpackaged Shock)	50 g
Emissions	IEC 61000-6-4
ESD immunity IEC 61000-4-2	8 kV contact discharges 10 kV air discharges
Radiated RF immunity IEC 61000-4-3	10V/m with 1 kHz sine-wave 80% AM from 80...2000 MHz 10V/m with 200 Hz 50% Pulse 100% AM at 900 MHz 10V/m with 200 Hz 50% Pulse 100% AM at 1890 MHz 3V/m with 1 kHz sine-wave 80% AM from 2000...2700 MHz
Conducted RF immunity IEC 61000-4-6	10V rms with 1 kHz sine-wave 80% AM from 150 kHz...80 MHz
EFT/B immunity IEC 61000-4-4	±4 kV at 5 kHz on power ports ±3 kV at 5 kHz on signal ports ±2 kV at 5 kHz on communication ports
Surge transient immunity IEC 61000-4-5	±1 kV line-line (DM) and ±2 kV line-earth (CM) on power ports ±1 kV line-line (DM) and ±2 kV line-earth (CM) on signal ports ±2 kV line-earth (CM) on communication ports
Reaction time	
Input reaction time, max	16.2 ms + set values of ON/OFF delays
Output reaction time, max	6.2 ms + (20 ms) relay response time

Signal sequence

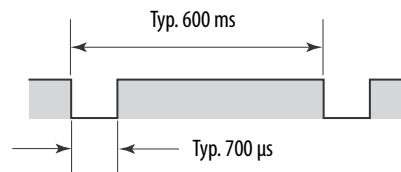


While safety outputs are in an on state, the signal sequence shown in the figure is output continuously for fault diagnosis. Confirm response time of device connected to safety outputs so the device does not malfunction due to off pulse.

**Table 76 - 1732ES-IB16, 1732ES-IB8X0B8, 1732ES-IB8X0BV4, 1732ES-IB12X0B4, and 1732ES-IB12X0BV2 Modules – Environmental Specifications**

Attribute	Value
Temperature, operating IEC 60068-2-1 (Test Ad, Operating Cold), IEC 60068-2-2 (Test Bd, Operating Dry Heat), IEC 60068-2-14 (Test Nb, Operating Thermal Shock)	-20...+55 °C (-4...+131 °F) (All 1732ES modules except 1732ES-IB16 modules)
Temperature, operating IEC 60068-2-1 (Test Ad, Operating Cold), IEC 60068-2-2 (Test Bd, Operating Dry Heat), IEC 60068-2-14 (Test Nb, Operating Thermal Shock)	-20...+60 °C (-4...+140 °F) (Only 1732ES-IB16 modules)
Temperature, nonoperating IEC 60068-2-1 (Test Ab, Unpackaged Nonoperating Cold), IEC 60068-2-2 (Test Bb, Unpackaged Nonoperating Dry Heat), IEC 60068-2-14 (Test Na, Unpackaged Nonoperating Thermal Shock)	-40...+85 °C (-40...+185 °F)
Relative humidity IEC 60068-2-30 (Test Db, Unpackaged Nonoperating Damp Heat)	5...95% noncondensing
Vibration IEC 60068-2-6 (Test Fc, Operating)	5 g at 10...500 Hz
Shock, operating IEC 60068-2-27 (Test Ea, Unpackaged Shock)	30 g
Shock, nonoperating IEC 60068-2-27 (Test Ea, Unpackaged Shock)	50 g
Emissions	IEC 61000-6-4
ESD immunity IEC 61000-4-2	4 kV contact discharges 10 kV air discharges
Radiated RF immunity IEC 61000-4-3	10V/m with 1 kHz sine-wave 80% AM from 80...2000 MHz 10V/m with 200 Hz 50% Pulse 100% AM at 900 MHz 10V/m with 200 Hz 50% Pulse 100% AM at 1890 MHz 3V/m with 1 kHz sine-wave 80% AM from 2000...2700 MHz
Conducted RF immunity IEC 61000-4-6	10V rms with 1 kHz sine-wave 80% AM from 150 kHz...80 MHz
EFT/B immunity IEC 61000-4-4	±2 kV at 5 kHz on power ports ±1 kV at 5 kHz on signal ports ±1 kV at 5 kHz on communication ports
Surge transient immunity IEC 61000-4-5	±2 kV line-earth (CM) on power ports ±2 kV line-earth (CM) on signal ports ±2 kV line-earth (CM) on communication ports
Reaction time	
Input reaction time, max	16.2 ms + set values of ON/OFF delays
Output reaction time, max	6.2 ms + (20 ms) relay response time

Signal sequence



While safety outputs are in an on state, the signal sequence shown in the figure is output continuously for fault diagnosis. Confirm response time of device connected to safety outputs so the device does not malfunction due to off pulse.

## Certifications

This section provides certification information for the 1791ES and 1732ES modules.

**Table 77 - 1791ES and 1732ES Modules – Certifications**

Certification <sup>(1)</sup>	1732ES-IB16, 1732ES-IB8XOB8, 1732ES-IB8XOBV4, 1732ES-IB12XOBV2, 1732ES-IB12XOB4, 1791ES-IB16, 1791ES-IB8XOBV4
CE	European Union 2004/108/EC EMC Directive, compliant with these norms: EN 61326-1; Meas./Control/Lab, Industrial Requirements EN 61000-6-2; Industrial Immunity EN 61000-6-4; Industrial Emissions EN 61010-2-201; Control Equipment Safety Requirements EN 61131-2; Programmable Controllers (Clause 8, Zone A & B)
EtherNet/IP	ODVA conformance tested to CIP Safety on EtherNet/IP specifications
KC	Korean Registration of Broadcasting and Communications Equipment, compliant with Article 58-2 of Radio Waves Act, Clause 3
RCM, C-Tick	Australian Radiocommunications Act, compliant with: EN 61000-6-4; Industrial Emissions
TUV	Capable of Cat. 4/PL e according to EN ISO 13849-1 and SIL 3 according to EN 62061/IEC 61508 <sup>(2)</sup>
c-UL-us	UL Listed Industrial Control Equipment, certified for US and Canada. See UL File E65584. UL Listed for Class I, Division 2 Group A,B,C,D Hazardous Locations, certified for U.S. and Canada. See UL File E194810. (1791ES only)
C-Tick	Australian Radiocommunications Act

(1) When marked. See the Product Certification link at <http://www.ab.com> for Declarations of Conformity, Certificates, and other certification details.

(2) When used with specified firmware revisions, and as described in the GuardLogix® 5570 and Compact GuardLogix 5370 Controller Systems Safety Reference Manual, publication [1756RM-099](#), and the Guard I/O™ EtherNet/IP Safety Modules, publication [1791ES-UM001](#).

## Europe

The type approval of TÜV-Rheinland addresses compliance to applicable requirements of the following directives and standards:

- EU legislation
  - Low-voltage Directive 73/23/EEC
  - EMC Directive 89/336/EEC
- European standards
  - EN 61508 (SIL1-3)
  - EN 61131-2
  - EN 60204-1
  - IEC 61000-6-2
  - IEC 61000-6-4
  - ISO 13849-1:2008



## North America

In North America, the TÜV-Rheinland type approval includes Guard I/O compliance to the relevant standards and related information including the following:

- U.S. standards - ANSI RIA15.06, ANSI B11.19, NFPA 79
- The modules are UL-certified functionally safe and carry the NRGF label, when product is marked (only 1791ES modules).

## Japan

In Japan, type test requirements are provided in Article 44 of the Industrial Safety and Health Law. These requirements apply to complete systems and cannot be applied to a module by itself. Accordingly, to use the module in Japan as a safety device for press machine or shearing tool pursuant to Article 42 of the above-mentioned law, it is necessary to apply for testing of the entire system (only 1791ES modules).

## EC Directives

These products conform to the EMC Directive and Low-voltage Directive. For additional information, see the relevant installation instructions.

### EMC Directive

Rockwell Automation devices that comply with EC directives also conform to the related EMC standards so that they can more easily be built into other devices or the overall machine. The actual products have been checked for conformity to EMC standards. Whether they conform to the standards in the system used by the customer, however, must be confirmed by the customer.

EMC-related performance of Rockwell Automation devices that comply with EC directives vary depending on the configuration, wiring, and other conditions of the equipment or control panel in which the Rockwell Automation devices are installed. The customer must, therefore, perform the final check to confirm that devices and the overall machine conform to EMC standards.

### Compliance with EC Directives

EtherNet/IP products that comply with EC directives must be installed as follows:

- All Type IP20 EtherNet/IP units must be installed within control panels.

- Use reinforced insulation or double insulation for the DC power supplies used for the communication power supply, internal- circuit power supply, and the I/O power supplies.
- EtherNet/IP products that comply with EC directives also conform to the Common Emission Standard (EN 50081-2). Radiated emission characteristics (10-m regulations) can vary depending on the configuration of the control panel used, other devices connected to the control panel, wiring, and other conditions. You must confirm that the overall machine or equipment complies with EC directives.

## Symbols

**+24V DC power current**  
input 56  
output 57

## Numerics

**1732ES-IB12XOB4** 33  
**1732ES-IB12XOBV2** 33  
**1732ES-IB16** 33  
**1732ES-IB8XOB8** 33  
**1732ES-IB8XOBV4** 33  
**1791ES-IB16** 33  
**1791ES-IB8XOBV4** 33

## A

**architectures, safety** 34

## B

**before you begin** 27

## C

**CAT. 4, PLc** 31, 34  
**CE LVD compliance** 33  
**CIP generic message instructions** 101  
**CIP Safety** 93  
**common terms** 9  
**compliance with EC directive** 169  
**configuration**  
reference information 159  
**conformity**  
codes 28  
regulations 28  
standards 28  
**controlling devices** 26  
**CRTL** 86

## D

**DC power supply according to**  
EN 50178 33  
IED/EN 60950 33  
UL 508 33  
**Device Level Ring** 9  
**diagnostic status information** 101  
**diagnostics** 12  
**dialog**  
Safety 86  
**DIN rail** 48  
**directives** 168  
**discrepancy time** 17  
**DLR**  
See Device Level Ring

**door interlocking switches** 26  
**dual-load bipolar outputs** 73, 74

## E

**electric shock**  
prevention 45  
**Electronic Data Sheet** 9  
**EMC Directives** 169  
**emergency stop switch** 26, 67  
**EN 50081-2** 170  
**EtherNet/IP cables**  
recommended 59  
**EtherNet/IP safety network** 34  
**explicit messages** 149  
**Explicit Messaging** 101, 102  
**explosion hazards** 42  
**external power supply** 33

## F

**fatal errors** 12  
**fault recovery** 20, 25  
**features**  
Guard I/O modules 32  
**firmware revision information**  
Guard I/O modules 28  
**forcibly-guided contacts** 26

## G

**get point status information** 101  
**glossary** 9  
**Guard I/O modules**  
features 32  
firmware revision information 28  
**Guardmaster product** 26

## H

**help button** 75

## I

**I/O**  
configuration tree 77  
connectors 32  
module overview 31  
status data 32  
**I/O assembly and reference data** 140  
**I/O connector cables, recommended** 62  
**I/O data** 136  
**IEC 61508** 31, 34, 151  
**IP rating for 1732ES modules** 43  
**ISO 13849-1** 31, 34  
2008 151

**J**

**Japan** 169

**L**

**limit switches** 26

**M**

**maximum current** 56  
**mean time between failure** 9, 151  
**model types** 32  
**module**  
     cleaning 42  
     configuration 75  
     definition 80  
**mounting guidelines** 45  
**MTBF**  
     See mean time between failure.  
**MTTF** 151  
**muting lamp** 21  
     output wiring 70

**N**

**NAT** 80  
     See network address translation  
**network (IP) address**  
     setting 52  
**network address switches** 75  
**network address translation** 9, 32, 80  
**node address setting** 52  
**North America** 169

**O**

**ODVA** 9  
**off-delay function** 20  
**on-delay function** 20  
**online help** 75  
**out-of-box condition** 44  
**outputs**  
     safety 32  
     test 32

**P**

**parameter groups** 159  
**PFD** 151  
     See probability of failure on demand.  
**PFH** 151  
     See probability of failure per hour  
**point status information** 101  
**power pass through** 55  
**precautions for use** 30  
**probability of failure**  
     on demand 151  
     per hour 151

**probability of failure on demand** 9  
**probability of failure per hour** 9  
**programming requirements** 34

**R**

**redundant channel safety devices** 17  
**replacement stock** 44  
**reset ownership** 87  
**RPI** 86  
**RSLogix 5000 software**  
     version 34

**S**

**safety**  
     administrator 30  
     category 30  
     integrity level 30  
**safety architectures** 34  
**safety functions**  
     safety input 13, 32  
     safety output 23, 32  
     understanding operation 11  
**safety network number** 9, 79, 93  
**safety precautions** 168  
**safety state** 11  
**self-diagnostics** 12  
**SIL CL 3** 31, 34  
**SNN** 79  
     See safety network number.  
**software versions** 34  
**standards** 168  
**status bits**  
     muting 21, 22  
**status data** 12  
**status messages**  
     1732ES modules 112  
     1791ES-IB16 modules 107  
     1791ES-IB8XOBV4 modules 102  
**status, combined** 12  
**Studio 5000 Logix Designer application**  
     version 34

**T**

**tag values and states**  
     input data 85  
     output data 85  
**terminology** 9  
**test outputs** 21, 32  
**topology**  
     DLR 35  
     linear 34  
     star 34  
**transformer, according to**  
     IEC/EN 61558 33

---

## W

### wiring by application

- dual-load bipolar outputs 73
- dual-load sourcing outputs – only 1732ES-IB12XOB4 module 74
- emergency stop switch dual-channel inputs with manual reset 67
- Guard I/O module with limit switch dual-channel inputs and a manual reset 72
- limit switch dual-channel inputs and a manual reset 71
- mode select switch 69
- muting lamp output 70
- two-hand monitor 68

### wiring examples 63

- door monitor 65
- emergency stop switch 65
- light curtain 66
- reset switch 64
- single-channel safety device 64

### wiring guidelines 43, 52

### wiring requirements

- ISO 13849-1:2008 67, 68, 71, 73, 74

**Notes:**



## Rockwell Automation Support

Use the following resources to access support information.

<b>Technical Support Center</b>	Knowledgebase Articles, How-to Videos, FAQs, Chat, User Forums, and Product Notification Updates.	<a href="https://rockwellautomation.custhelp.com/">https://rockwellautomation.custhelp.com/</a>
<b>Local Technical Support Phone Numbers</b>	Locate the phone number for your country.	<a href="http://www.rockwellautomation.com/global/support/get-support-now.page">http://www.rockwellautomation.com/global/support/get-support-now.page</a>
<b>Direct Dial Codes</b>	Find the Direct Dial Code for your product. Use the code to route your call directly to a technical support engineer.	<a href="http://www.rockwellautomation.com/global/support/direct-dial.page">http://www.rockwellautomation.com/global/support/direct-dial.page</a>
<b>Literature Library</b>	Installation Instructions, Manuals, Brochures, and Technical Data.	<a href="http://www.rockwellautomation.com/global/literature-library/overview.page">http://www.rockwellautomation.com/global/literature-library/overview.page</a>
<b>Product Compatibility and Download Center (PCDC)</b>	Get help determining how products interact, check features and capabilities, and find associated firmware.	<a href="http://www.rockwellautomation.com/global/support/pcdc.page">http://www.rockwellautomation.com/global/support/pcdc.page</a>

## Documentation Feedback

Your comments will help us serve your documentation needs better. If you have any suggestions on how to improve this document, complete the How Are We Doing? form at [http://literature.rockwellautomation.com/idc/groups/literature/documents/du/ra-du002\\_-en-e.pdf](http://literature.rockwellautomation.com/idc/groups/literature/documents/du/ra-du002_-en-e.pdf).

Rockwell Automation maintains current product environmental information on its website at <http://www.rockwellautomation.com/rockwellautomation/about-us/sustainability-ethics/product-environmental-compliance.page>.

Allen-Bradley, ArmorBlock, CompactBlock, Guard I/O, GuardLogix, GuardMaster, POINT Guard I/O, Rockwell Automation, Rockwell Software, RSLinx, RSLogix, RSLogix 5000, RSNetWorx, RSView, Stratix, Studio 5000, and Studio 5000 Logix Designer are trademarks of Rockwell Automation, Inc.

CIP Safety, ControlNet, DeviceNet and EtherNet/IP are trademarks of ODVA, Inc. Trademarks not belonging to Rockwell Automation are property of their respective companies.

Rockwell Otomasyon Ticaret A.Ş., Kar Plaza İş Merkezi E Blok Kat:6 34752 İçerenköy, İstanbul, Tel: +90 (216) 5698400

**[www.rockwellautomation.com](http://www.rockwellautomation.com)**

### Power, Control and Information Solutions Headquarters

Americas: Rockwell Automation, 1201 South Second Street, Milwaukee, WI 53204-2496 USA, Tel: (1) 414.382.2000, Fax: (1) 414.382.4444

Europe/Middle East/Africa: Rockwell Automation NV, Pegasus Park, De Kleetlaan 12a, 1831 Diegem, Belgium, Tel: (32) 2 663 0600, Fax: (32) 2 663 0640

Asia Pacific: Rockwell Automation, Level 14, Core F, Cyberport 3, 100 Cyberport Road, Hong Kong, Tel: (852) 2887 4788, Fax: (852) 2508 1846

Publication 1791ES-UM001G-EN-P - November 2016

Supersedes Publication 1791ES-UM001F-EN-P - July 2015

Copyright © 2016 Rockwell Automation, Inc. All rights reserved. Printed in the U.S.A.